

BITEC, Inc. a reliable U.S. Manufacturer, known for producing the highest quality, advanced technology Modified Bitumen Membranes, is proud to announce its latest product to the roofing industry...

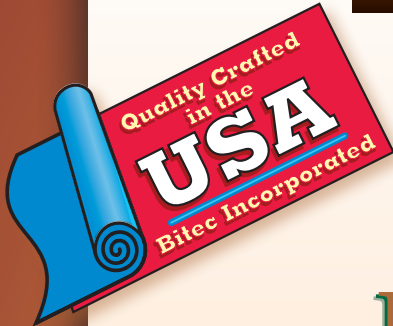

Self-Adhering

MAT-40™

METAL & TILE UNDERLAYMENT

MAT-40 is a durable waterproofing tile and metal roofing underlayment consisting of high-strength, dimensionally stable polyester, in combination with fiberglass scrim. MAT-40 is coated with a specially formulated SBR polymer modified adhesive applied to the roll's bottom surface. A split release film, treated with silicone, is applied to the adhesive surface to facilitate application. Top surface is composed of polyester fabric. A 2-inch selvedge edge is applied to the top surface in order to create a waterproof seal at side laps. MAT-40 can be applied in conditions where roof temperatures reach 260°F (126.7°C). Meets ASTM D1970.

- Monolithic coating and saturating process, not laminated or dual-compound. This means 100% waterproofing performance and ease of application.
- Modifier is 100% SBR.
- Resists punctures and tears.
- Excellent surface for polyurethane foam adhesive.
- Retains roof-loaded tiles with no degradation of waterproofing properties of the product.
- Can be left exposed to weather for 120 days without deterioration or substantial physical property changes.
- No abrasive surface to contact with metal roof panels.
- Self-sealing around nails.
- Polyester fabric will not rot or decay.
- Economical to use.

SPECIFICATIONS (approx.)

Roll Size (2 sq.)	64.5 ft ² x 3.28 ft ²	19.7 m x 1 m
Coverage	200 ft ²	18.7 m ²
Roll Weight	80 lbs.	36.4 kg
Weight per 100 ft ²	40 lbs	17.9 kg
Top Surface	Polyester Fabric	
Bottom Surface	SBR Polymer Bitumen	
Min. Installation Temp.	55°F	13°C

MAT-40 contains high-quality distilled asphalt and "made-on-purpose" polymers, creating a monolithic sheet that is free of brittle, non-flexible oxidized asphalt. Only the highest quality raw materials are used in making BITEC products.



Visit our web site at www.bi-tec.com

P.O. Box 497 • No. 2 Industrial Park Drive • Morrilton, Arkansas 72110 • Fax (501) 354-3019 • Phone 1-800-535-8597

MANUFACTURERS OF ADVANCED TECHNOLOGY WATERPROOFING MEMBRANES

SURFACE PREPARATION AND INSTALLATION

Prior to application make certain that all surfaces which will receive MAT-40 are clean, smooth and dry. Small amounts of dust, moisture and contamination can affect the adhesive properties of the product. **IT IS NECESSARY TO REMOVE THE PLASTIC SELVEDGE EDGE FILM PRIOR TO INSTALLATION.**

Application is performed by beginning at the lowest point of the roof. Install courses of material perpendicular to the roof slope. Stagger and offset end laps by at least three ft. (3'). Install with minimum two in. (2") side lap; minimum three in. (3") end lap. Release film must be removed as roll is applied to provide proper adhesion to deck surfaces.

END LAP TREATMENT: It is recommended, but is not required, to create a watertight seal at end lap. Do so by using modified adhesive or urethane caulk; then apply pressure evenly using a weighted roller over end lap to create a proper seal.

We also recommend that heavy grade asphalt primer (ASTM D 41) be applied to all masonry, metal and wood surfaces receiving the factory installed adhesive. (Note: It is not necessary to use primer on exposed metal roof panels. It is not mandatory to prime plywood decking; however it is recommended.) Treat valleys, roof penetrations, hip and ridge as well as eaves as you would when applying organic felt underlayment. It may be necessary to consult the metal roof or tile manufacturer for specific guidelines concerning installation of this underlayment.

In most instances, MAT-40 should be installed as would any other underlayment membrane. The major difference with MAT-40 is that it is a self-adhering (peel & stick) product with a silicone release paper on the bottom side. Install MAT-40 only over clean surfaces so as not to contaminate the adhesive side. Using a 75 lb. roller, roll in the underlayment to remove any trapped air and insure the best possible adhesion.

Care must also be exercised to eliminate wrinkles in the installation. This will require pre-planning for conditions such

as edges, walls, valleys, hips, ridges, curbs, and several types of roof penetrations.

Since MAT-40 is a self-adhered waterproof membrane, no additional membrane is required for perimeter ice dam protection.

In assemblies where metal roofing is installed directly over insulation, an underlayment should be installed on top of the insulation to catch any condensation or ice melt. Ventilation under metal decks should be considered based on the climactic conditions due to project location and the design requirements of the building. In all assemblies, the recommendations of the metal roofing panel manufacturer should be followed.

When using MAT-40 under metal roofs, BITEC agrees with the NRCA recommendation of a min. slope of $\frac{1}{2}$ " per foot. For metal roof installations, additional slip sheets may be installed over MAT-40 when required by project specifications.

When using MAT-40 under tile roofs, BITEC agrees with the NRCA recommendation of a min. slope of 4" per foot. On slopes less than 4:12, a primary weatherproof roof membrane should be installed before the tile is installed.

Installers should familiarize themselves with the project requirements and refer to the standard guidelines set forth in manuals published by NRCA, FRSA, and the Roof Tile Institute in conjunction with Western States Roofing Contractors Association and with other pertinent publications. All tile and metal roof products should be installed in compliance with specific manufacturer's recommendations. Where there are differences in requirements, the most stringent usually applies. However, all parties to any installation should be in full agreement before an installation is begun.

The following diagrams are only intended to indicate some of the basic uses for MAT-40 as an underlayment for metal and tile roofs. There are many special conditions that can be adapted from these basic details.

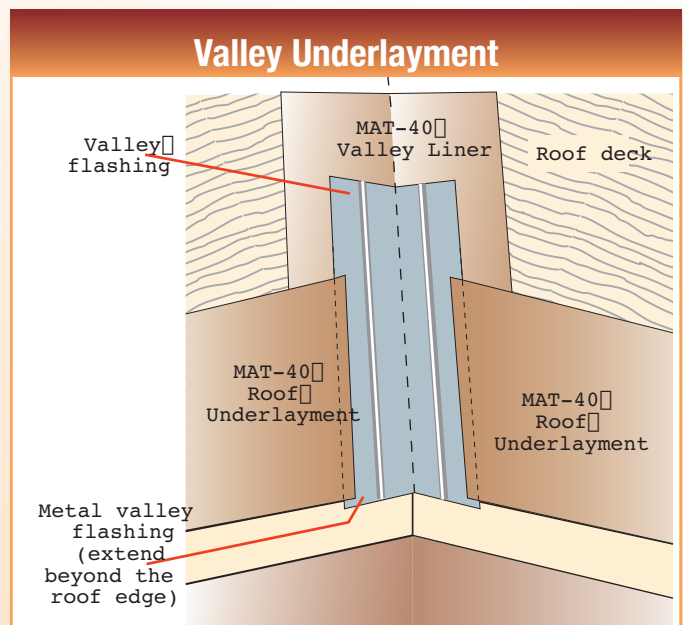
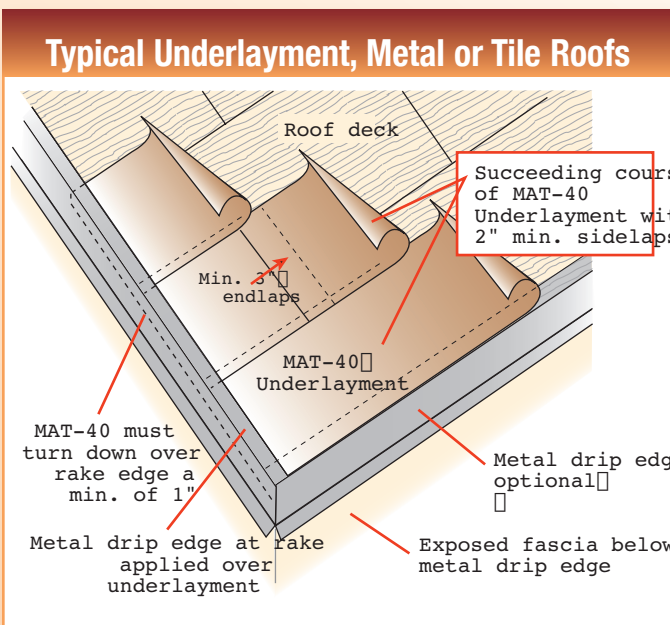

Ice Dam Protection

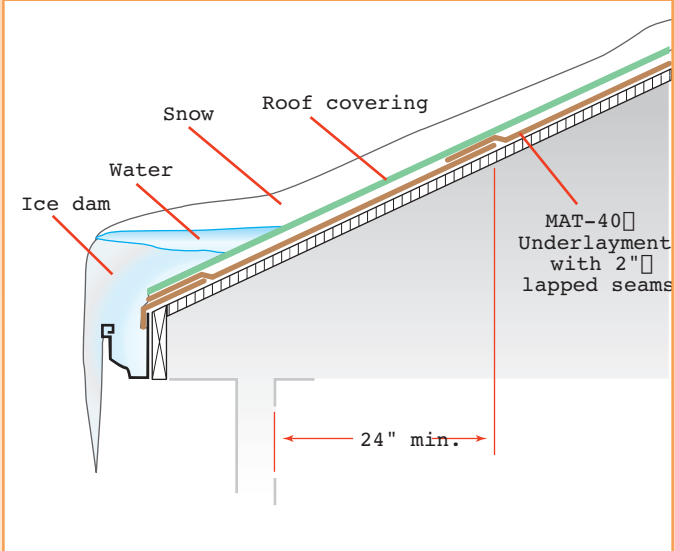

Typical Metal Roof Installation

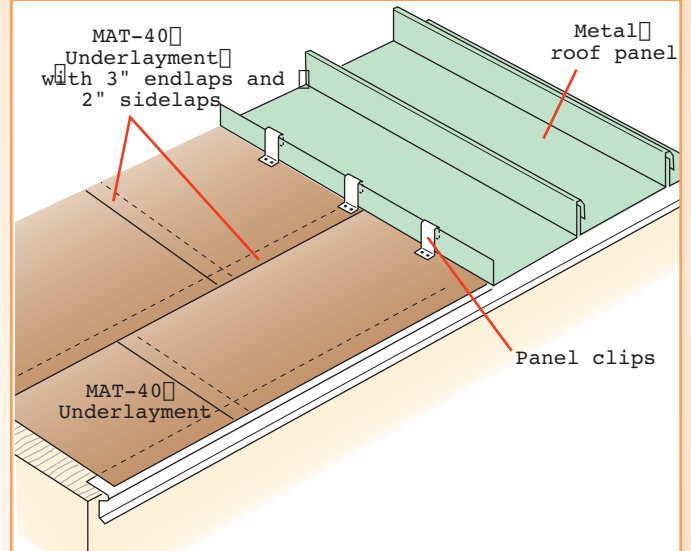

Typical Use of Z-Purlins with Insulation

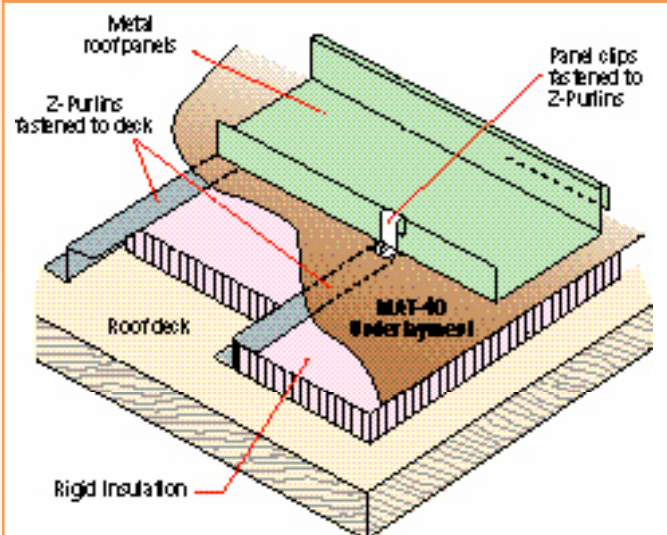

Bearing Plate & Panel Clip Over Insulation

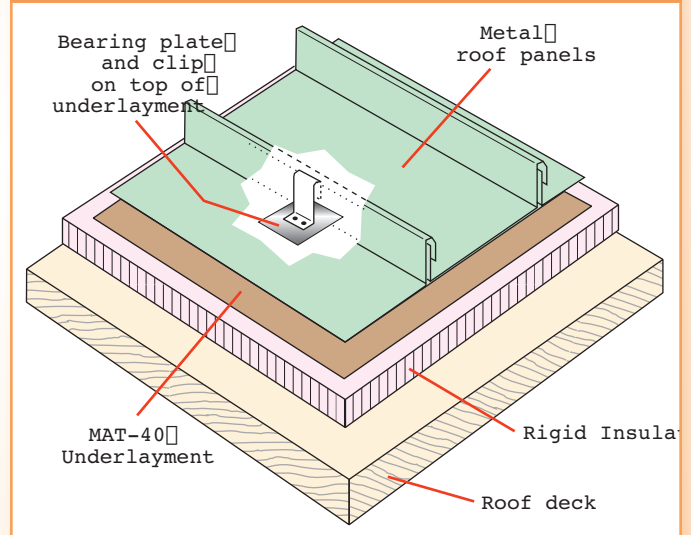

Flat Tile With Battens and Raised Edge

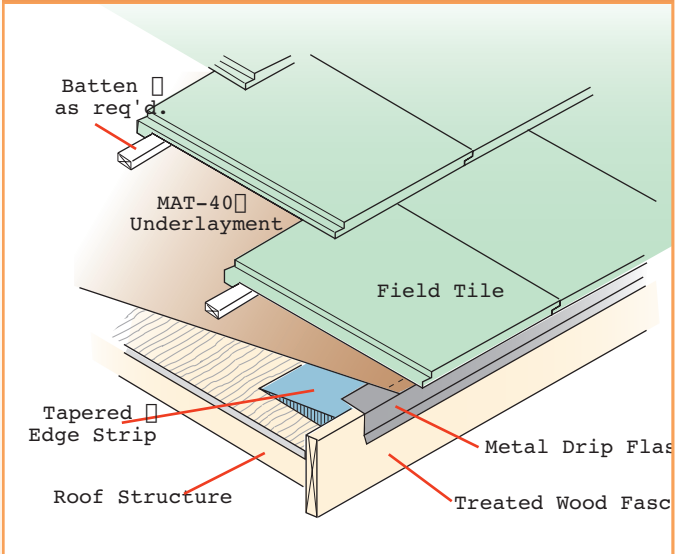

Flat Tile Installation Without Battens

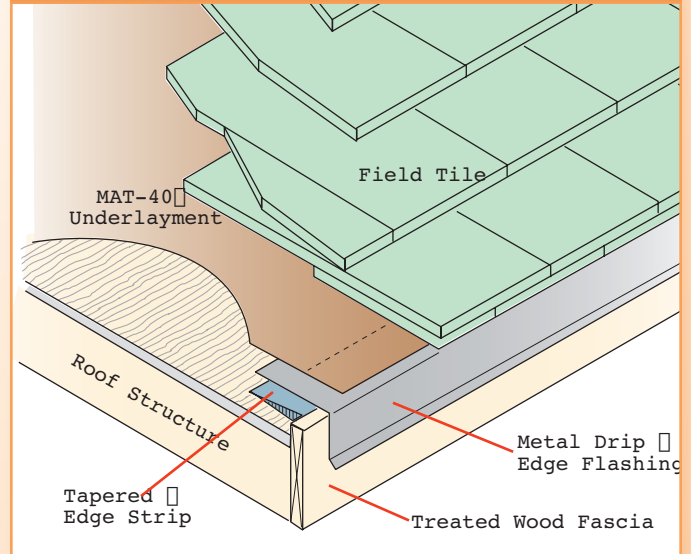

Roof Curb Underlayment Detail

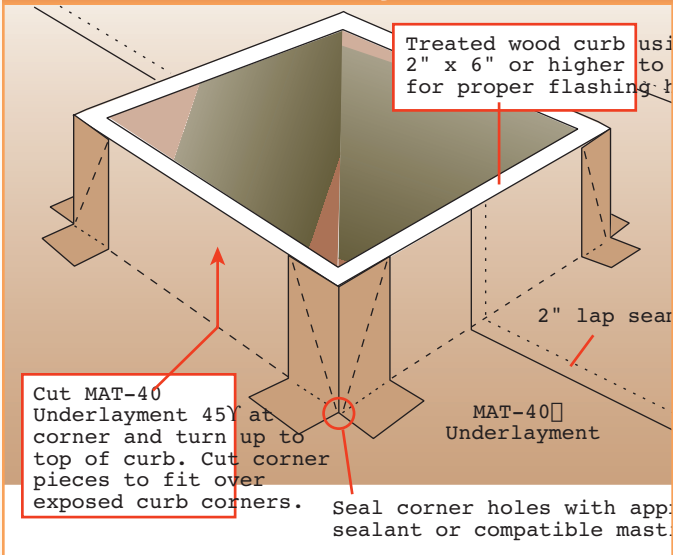

Barrel Tile Sidewall Detail

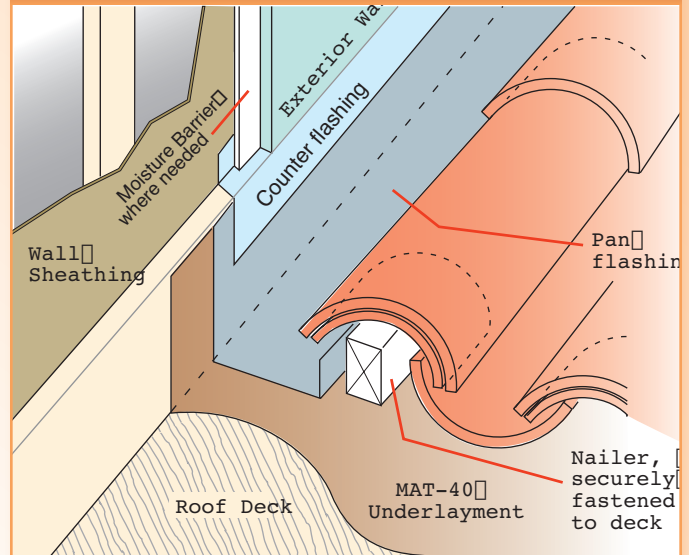

Typical Wood Batten System

Nom. 1" x 2" min. wood battens, separate ends approx. 1/2" every 4' or provide shims under battens to prevent trapping water. Battens may be saw-kerfed to provide drainage. Space as required to suit roof tile

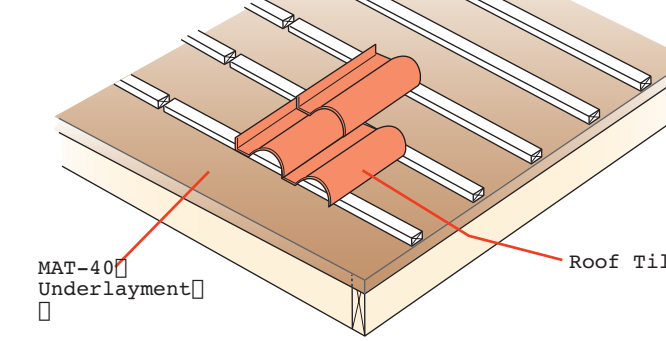

Typical Wood Batten/Counterbatten System

Nom. 1" x 2" min. wood battens Counter battens at 24" o.c. max.

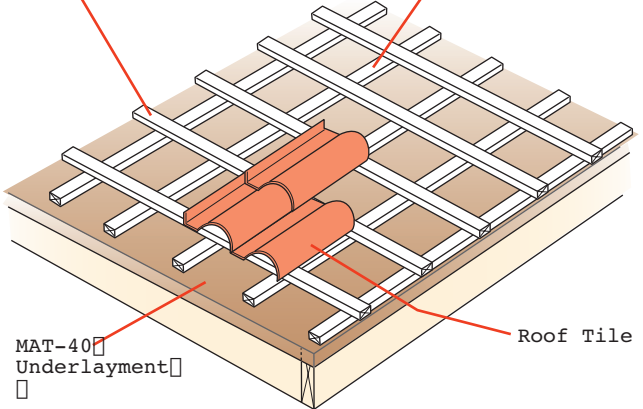

STORAGE AND HANDLING: Store MAT-40 in its original container on pallets, inside or under cover, protected from the elements. Avoid prolonged storage above 90°F (32°C). Product may stick together if stored at elevated temperatures. Do not store product in moisture-prone areas. Keep MAT-40 upright until immediately before use. Store any remaining membrane in original container to protect it for future use.

CAUTION:

- Dispose of any unused MAT-40 in accordance with local codes. (MAT-40 product does not contain asbestos.)
- MAT-40 should not be used in any interior space due to its asphaltic odor.
- MAT-40 can be slippery when wet or covered with frost and/or ice.
- Keep MAT-40 and all roofing components away from children and animals.
- Other conditions may apply to the use and installation of MAT-40.

- Never use MAT-40 product for any purpose other than its intended use. Misuse of or abuse to the product may result in property damage or personal injury.
- BITEC, INC. assumes no responsibility for any loss arising from misuse and/or misapplication of its products.

More information about this product can be obtained by calling your local BITEC sales representative or 800-535-8597, or at www.bi-tec.com.

This brochure contains the most up-to-date information on MAT-40; however, changes and modifications to this publication and to MAT-40 may be made without notice.

As with all roofing installations, it is the responsibility of the contractor or installer to provide for adequate fall protection for all personnel engaged in the roofing and construction phase.

Information contained herein is given in good faith and concerns data gathered during normal production of material. BITEC, Inc. reserves the right to change and/or modify its products at any time, and without prior notice.