

# Metal Sales Product Catalog

## *Metal Roof & Wall Panels Products*



Architectural  
Commercial  
Post Frame  
Residential

**ms** metal sales<sup>TM</sup>  
manufacturing corporation

# THE METAL SALES DIFFERENCE

For more than 55 years, Metal Sales Manufacturing Corporation has earned a reputation as the premier provider of innovative metal building components and accessories. We've backed this reputation with the industry's largest professional sales and service team, supported by 21 branches located throughout the United States.

We offer a full line of exceptional quality metal roof and wall panels for agricultural, commercial, architectural, industrial and residential projects of every shape and size – new construction or retrofit.

But our technology and durable designs are only part of the story. Architects, contractors and installers appreciate the impeccable service from our highly trained professional staff, ready to answer any question, or help devise custom solutions to your building and energy saving needs.

- Serving the architectural, commercial, residential, industrial and agricultural markets for over half a century
- In-house engineering and design assistance available
- A wide selection of materials and finishes available, including MS Colorfast45®, ColorFit40™, PVDF, Weathering Steel, Aluminum, Stainless Steel and Copper
- Over 75 profiles available with matching trim and accessories
- All standard colors meet or exceed steep slope ENERGY STAR® requirements and many are also LEED compliant
- 21 convenient locations nationwide, including Alaska
- Quoting and shipping projects worldwide
- Up to 45 year Finish Warranties available
- Panel testing including FM-4471, UL 580, ASTM E 1592 and approvals including Miami-Dade County, ICC Evaluation Report and Florida Building Code (FBC) 2017
- 30 year Weather-Tight Warranty available (on select profiles) **WTW**
- Curving capabilities available – (see pages 3 and 8)

*Metal Sales is dedicated to leading the metal building component industry, by setting new standards for operating efficiency, product design, active service management and lasting value. We strongly believe that by investing in our corporation, we will ensure the best products and services for our customers, high job satisfaction for our employees and continued innovation and growth for our industry.*

## Profile Selection

### STANDING SEAM PANELS

Magna-Loc, Magna-Loc 180.....	3	<b>WTW</b>
Curved Magna-Loc.....	3	<b>WTW</b>
T-Armor Series™.....	4	<b>WTW</b>
Seam-Loc 24®.....	5	<b>WTW</b>
Snap-Loc 24.....	5	<b>WTW</b>
Vertical Seam, Vertical Seam Plus.....	6	<b>WTW</b>
Clip-Loc.....	6	<b>WTW</b>

### CONCEALED FASTENED PANELS

Image II™.....	7	<b>WTW</b>
Mini-Batten, Curved Mini-Batten.....	8	
Box-Batten.....	8	
Maxi-Batten.....	8	
TL-17 Series.....	9	
Flush Face Series.....	10	
Concealed Fastened Wall Panels.....	11	<b>WTW</b>
Soffit Panel.....	12	

### EXPOSED FASTENED PANELS

T10 Series.....	13
7/8" Corrugated.....	14
5V-Crimp.....	14
IC72-Panel.....	15
V-Line 32.....	15
Exposed Fastened Series.....	16,17
Deep Rib Series.....	18
Industrial Rib Series.....	19

### METAL BUILDING PANELS

PBR-Panel.....	20
R-Panel.....	20
PBU-Panel.....	20
U-Panel.....	20
Pro-Panel II®.....	21
Classic Rib®.....	21
1.25" Corrugated.....	22
2.5" Corrugated.....	22
Strongpanel.....	23
Span-Line 36A.....	23
DL-3 Panel.....	24
Bi-Rib.....	24
Delta Rib.....	24
Dual Rib.....	24

### INSULATED WALL & ROOF PANELS

IMPower Series™.....	25
----------------------	----

### SECONDARY FRAMING

Retro-Master® and Metal-Over-Metal.....	26
Perforation, Mitered Corners, Curving Options.....	26
Secondary Framing.....	27
Coating Systems.....	27

## Magna-Loc, Magna-Loc 180

- ▶ Architectural/structural flat pan standing seam roof panel
- ▶ 16" or 18" panel coverage, 2" rib height
- ▶ Gauges: 24 ga. standard, 22 ga. optional
- ▶ Minimum roof slope: 1/2:12
- ▶ Factory-applied side lap sealant
- ▶ Mechanically seamed side lap
- ▶ Concealed clip designed for thermal movement
- ▶ Accommodates 1/2" to 6" blanket insulation
- ▶ Applies over open framing or solid substrate
- ▶ Finishes: PVDF and Acrylic Coated Galvalume®
- ▶ Contact Metal Sales for load-carrying capabilities



#### Testing and Approvals

- ▶ UL 263, Fire Resistance Rating – per assembly
- ▶ UL 580, Class 90 Wind Uplift, Construction #506, 506A and 506B
- ▶ UL 790, Class A Fire Resistance Rating – per assembly
- ▶ UL 2218, Class 4 Impact Resistance
- ▶ ASTM E 1592 Roof Uplift
- ▶ ASTM E 1646 Water Penetration - none at 12 psf\*
- ▶ ASTM E 1680 Air Leakage - 0.016 cfm/ft² at 12 psf\*
- ▶ ASTM E 2140 Water Penetration, Static Head - none\*
- ▶ Texas Department of Insurance Evaluation Report, RC-197
- ▶ Factory Mutual Approved, 1-90, 1-105, 1-165
- ▶ Miami-Dade County Approved, NOA 18-0901.01 and 18-0901.02
- ▶ ICC Evaluation Report, ESR-2385
- ▶ 2017 FBC Approved
  - Magna-Loc 24 ga. over 16 ga. Purlins, 10999.5
  - Magna-Loc 24 ga. over 5/8" Plywood, 11560.6
  - Magna-Loc 24 ga. over 22 ga. Metal Deck, 11560.7
  - Magna-Loc 0.032" or 0.040" Aluminum over 22 ga. Metal Deck, 10999.2
  - Magna-Loc 180 24 ga. over 16 ga. Purlins, 10999.6

\*with tube sealant at clip locations

## Curved Magna-Loc 180

- ▶ Architectural/structural standing seam roof panel
- ▶ 16" panel coverage, 2" rib height
- ▶ 24 ga. standard
- ▶ Minimum radius 20'-0"
- ▶ Field and factory curving available
- ▶ Pre-applied side lap sealant
- ▶ Mechanically seamed side lap
- ▶ Concealed clip designed for thermal movement
- ▶ Applies over open framing or solid substrate
- ▶ Finishes: PVDF and Acrylic Coated Galvalume®
- ▶ Contact Metal Sales for load-carrying capabilities

#### Testing and Approvals

- ▶ UL 263, Fire Resistance Rating – per assembly
- ▶ UL 580, Class 90 Wind Uplift, Construction #576, 577 and 583
- ▶ UL 790, Class A Fire Resistance Rating – per assembly
- ▶ UL 2218, Class 4 Impact Resistance
- ▶ ASTM E 1592 Roof Uplift
- ▶ ASTM E 1646 Water Penetration
- ▶ ASTM E 1680 Air Leakage
- ▶ 2017 FBC Approved
  - Magna-Loc 180 24 ga. over 16 ga. Purlins, 10999.6

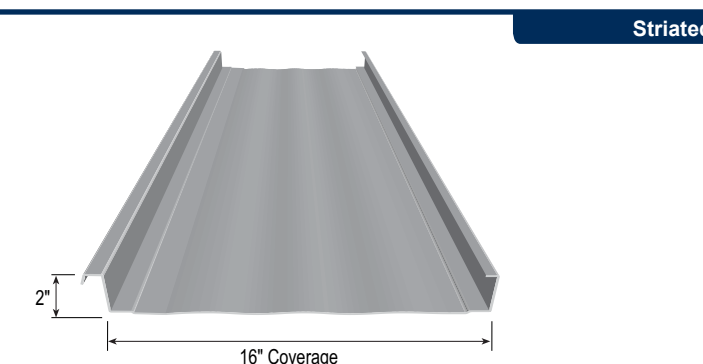
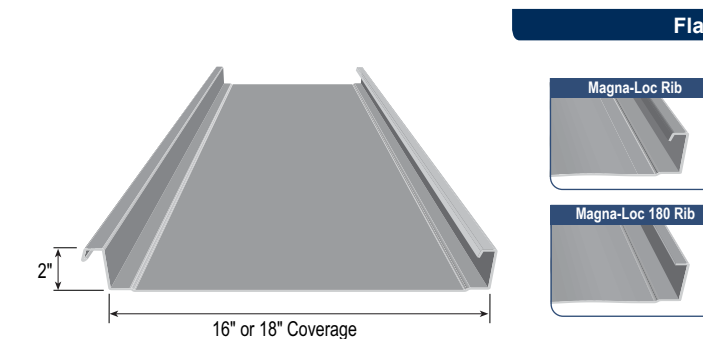
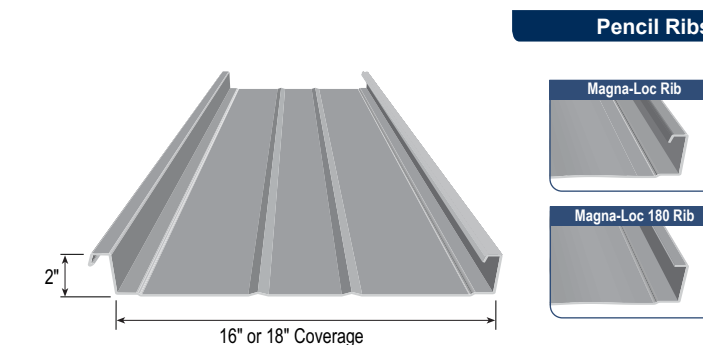
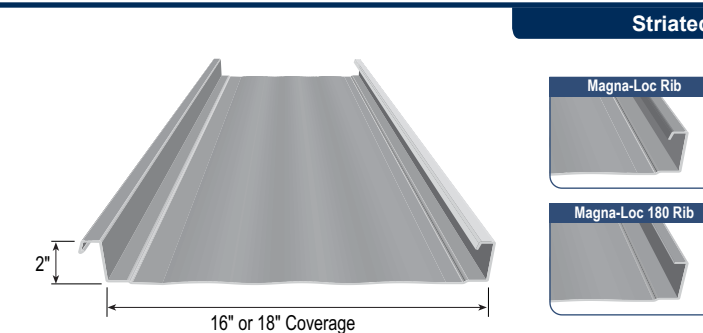

## T-Armor Series™

- ▶ Structural "T" standing seam roof panel
- ▶ 12", 16" and 18" panel coverage
- ▶ Rib Height: 2-3/8" and 3"
- ▶ Finishes: PVDF and Acrylic Coated Galvalume®
- ▶ Gauges: 24 ga. standard, 22 ga. and 20 ga. optional
- ▶ Aluminum: 0.032" and 0.040"
- ▶ Minimum roof slope: 1/2:12
- ▶ Integral mechanically seamed side lap
- ▶ "T" style rib allows for easy single panel replacement
- ▶ Factory-applied side lap sealant
- ▶ Concealed clip designed for thermal movement
- ▶ Accommodates 1/2" to 6" blanket insulation
- ▶ Applies over open framing or solid substrate
- ▶ Contact Metal Sales for load-carrying capabilities

Panel Cap Before Seaming

Panel Cap After Seaming

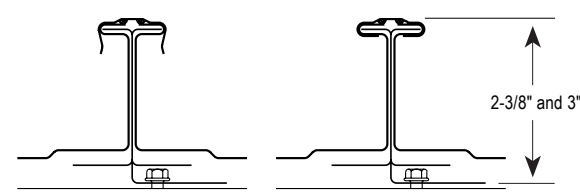

### Testing and Approvals

- ▶ UL 263, Fire Resistance Rating – per assembly
- ▶ UL 580, Class 90 Uplift, Construction #268, 268A and 268B
- ▶ UL 790, Class A Fire Resistance Rating – per assembly
- ▶ UL 1897, Uplift Load
- ▶ UL 2218, Class 4 Impact Resistance
- ▶ ASTM E 283 Air Infiltration
- ▶ ASTM E 330 Uniform Static Air Pressure Difference
- ▶ ASTM E 331 Water Penetration
- ▶ ASTM E 1592 Roof Uplift
- ▶ ASTM E 1646 Water Penetration
- ▶ ASTM E 1680 Air Leakage
- ▶ ASTM E 1886, 1996 Impact
- ▶ ASTM E 2140 Water Penetration, Static Head - none\*
- ▶ TAS 201, 203 Impact
- ▶ TAS 100, Wind Driven Rain
- ▶ ICC 500 / FEMA 361
- ▶ ICC Evaluation Report, ESR-3743
- ▶ AAMA 501.1, Dynamic Water
- ▶ FM 4470, Foot Traffic

\*with tube sealant at clip locations

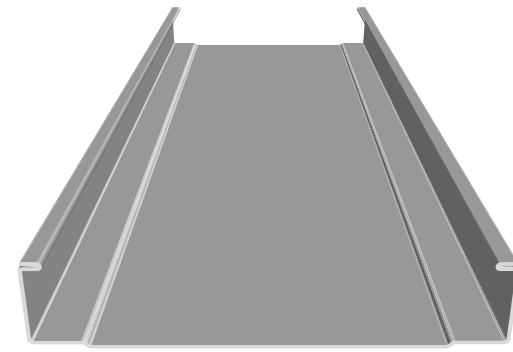

Flat

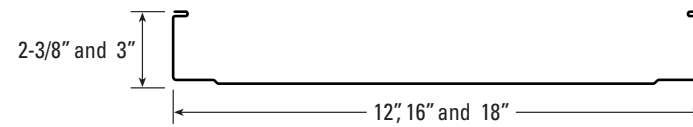

Striated

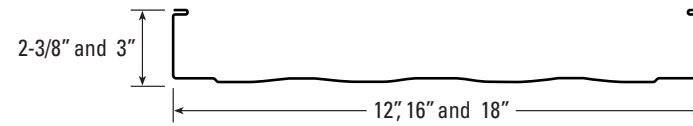

Pencil Rib

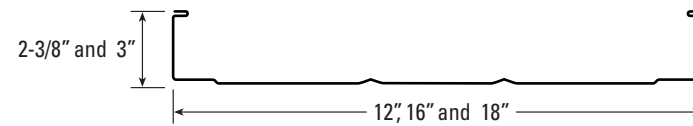

Minor Rib

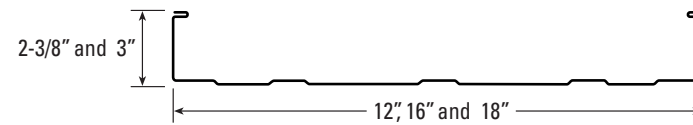

Plank

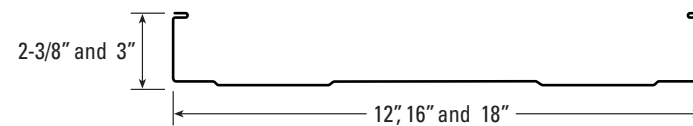

Mesa

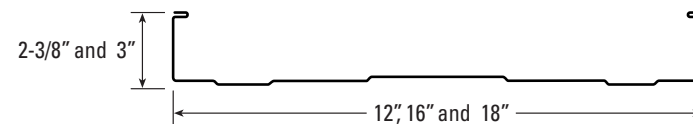

## Seam-Loc 24®

- ▶ Structural trapezoidal standing seam roof panel
- ▶ 24" or 18" panel coverage, 2-11/16" rib height
- ▶ Gauges: 24 ga. standard, 22 ga. optional
- ▶ Minimum roof slope: 1/4:12
- ▶ Factory-applied side lap sealant
- ▶ Pittsburgh double flat locking mechanically seamed side lap
- ▶ Concealed clip designed for thermal movement
- ▶ Accommodates 1/2" to 6" blanket insulation
- ▶ Applies over open framing or solid substrate
- ▶ Finishes: PVDF and Acrylic Coated Galvalume®
- ▶ Contact Metal Sales for load-carrying capabilities

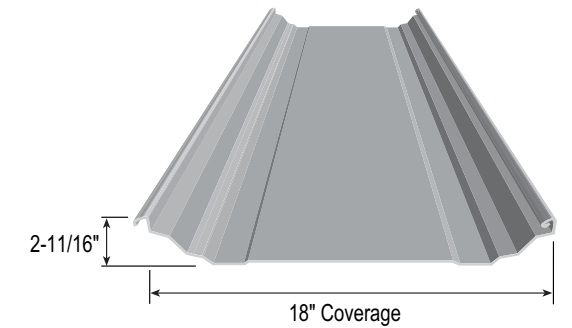
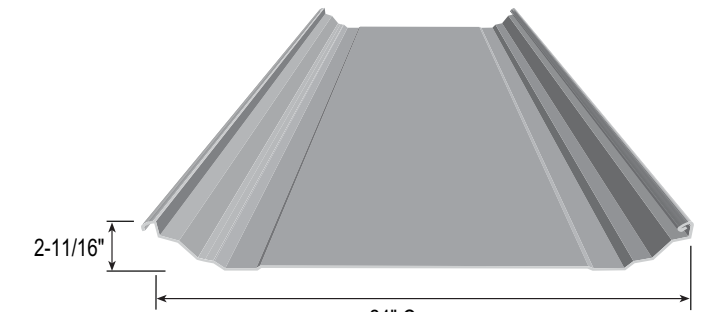

### Testing and Approvals

- ▶ UL 263, Fire Resistance Rating – per assembly
- ▶ UL 580, Class 90 Wind Uplift, Construction, #197 and 197A
- ▶ UL 790, Class A Fire Resistance Rating – per assembly
- ▶ UL 2218, Class 4 Impact Resistance
- ▶ ASTM E 1592 Roof Uplift
- ▶ ASTM E 1646 Water Penetration
- ▶ ASTM E 1680 Air Leakage
- ▶ Factory Mutual Approved, 1-90 and 1-165
- ▶ 2017 FBC Approved
  - 24" wide over 16 ga. Purlins, 10999.8
  - 24" wide (with clamps) over 16 ga. Purlins, 10999.9



## Snap-Loc 24®

- ▶ Structural trapezoidal standing seam roof panel
- ▶ 24" panel coverage, 3" rib height
- ▶ Gauges: 24 ga. standard, 22 ga. optional
- ▶ Minimum roof slope: 1/4:12
- ▶ Factory-applied side lap sealant
- ▶ Snap-together panel system
- ▶ Concealed clip designed for thermal movement
- ▶ Accommodates 1/2" to 6" blanket insulation
- ▶ Applies over open framing or solid substrate
- ▶ Finishes: PVDF and Acrylic Coated Galvalume®
- ▶ Contact Metal Sales for load-carrying capabilities

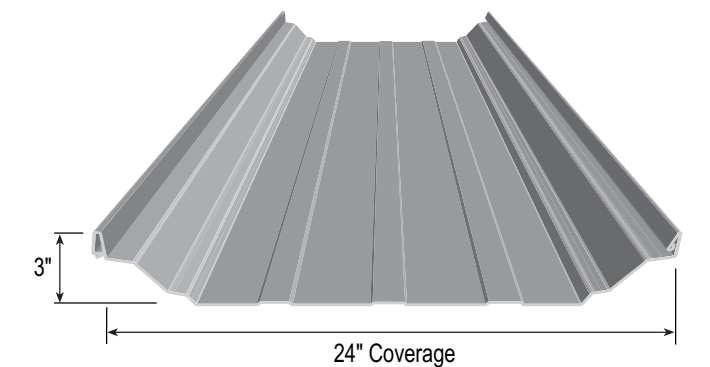

### Testing and Approvals

- ▶ UL 263, Fire Resistance Rating – per assembly
- ▶ UL 580, Class 90 Uplift, Construction, #240
- ▶ UL 790, Class A Fire Resistance Rating – per assembly
- ▶ UL 2218, Class 4 Impact Resistance
- ▶ ASTM E 330, Uniform Static Air Pressure Difference
- ▶ ASTM E 1592 Roof Uplift
- ▶ ASTM E 1646 Water Penetration
- ▶ ASTM E 1680 Air Leakage



## Vertical Seam

- ▶ Architectural/structural standing seam panel
- ▶ Panel Coverage: 12", 16" or 18"
- ▶ Rib Height: 1-3/4"
- ▶ Gauges: 26 ga. and 24 ga. standard, 22 ga. optional
- ▶ Snap-together panel system with factory-applied side lap sealant
- ▶ Minimum roof slope over open framing 3:12
- ▶ Minimum roof slope over solid substrate 1:12
- ▶ Concealed clip designed for unlimited thermal movement
- ▶ Accommodates up to 4" blanket insulation
- ▶ Finishes: PVDF, MS Colorfast45® and Acrylic Coated Galvalume®
- ▶ Contact Metal Sales for load-carrying capabilities

### Vertical Seam Plus

- ▶ Square Batten Cap option for Vertical Seam Panel
- ▶ Available at the Fontana Branch only

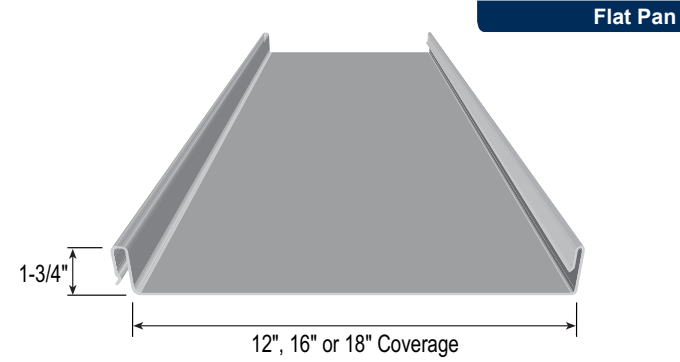
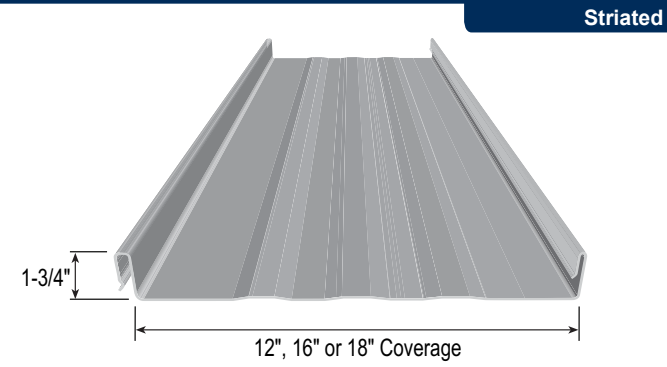
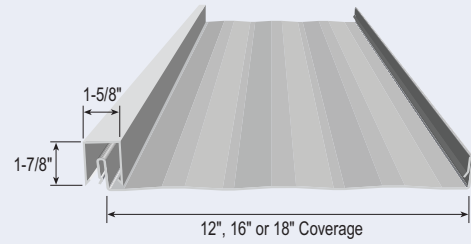

### Testing and Approvals

- ▶ UL 263, Fire Resistance Rating — per assembly
- ▶ UL 580, Class 90 Wind Uplift, Construction, #254, 255, 261, 303, 342, 343, 436, 445, 446, 447, 448, 508 and 508A
- ▶ UL 790, Class A Fire Resistance Rating — per assembly
- ▶ UL 2218, Class 4 Impact Resistance
- ▶ ASTM E 1592 Roof Uplift
- ▶ ASTM E 1646 Water Penetration
- ▶ ASTM E 1680 Air Leakage
- ▶ Miami-Dade County Approved, NOA 18-1227.01
- ▶ Texas Department of Insurance Evaluation Report, RC-412
- ▶ ICC Evaluation Report, ESR-2385
- ▶ 2017 FBC Approved
  - 26 ga. over 1/2" Plywood, 11560.12 (16" Panel)
  - 24 ga. over 1/2" Plywood, 11560.10 (16" Panel)
  - 24 ga. over 1/2" Plywood, 11560.13 (16" Panel)
  - 24 ga. over 1/2" Plywood, 11560.11 (18" Panel)
  - 24 ga. over 1/2" Plywood, 11560.14 (18" Panel)
  - 0.032" Aluminum over 7/16" OSB, 14645.6 (16" Panel)
  - 0.032" Aluminum over 5/8" Plywood, 14645.7 (16" Panel)



## Clip-Loc

- ▶ Architectural/structural integral standing rib roof system
- ▶ Snap-together panel system
- ▶ 16" panel coverage, major rib: 8" centers, 1-5/8" rib height
- ▶ Gauges: 26 ga., 24 ga. standard and 22 ga. optional
- ▶ Minimum roof slope: 1:12
- ▶ Applies over open framing or solid substrate
- ▶ Concealed clip designed for thermal movement
- ▶ Accommodates up to 4" blanket insulation
- ▶ Finishes: PVDF and Acrylic Coated Galvalume®
- ▶ Contact Metal Sales for load-carrying capabilities

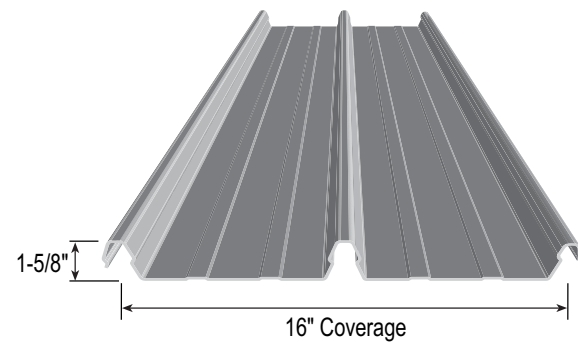

### Testing and Approvals

- ▶ UL 263, Fire Resistance Rating — per assembly
- ▶ UL 580, Class 90 Wind Uplift, Construction, #586 and 586A
- ▶ UL 790, Class A Fire Resistance Rating — per assembly
- ▶ UL 1897, Uplift Tests for Roof Covering Systems
- ▶ UL 2218, Class 4 Impact Resistance
- ▶ ASTM E 1592 Roof Uplift
- ▶ ASTM E 1680 Air Leakage
- ▶ ICC Evaluation Report, ESR-2385

## Image II

- ▶ Architectural concealed direct-fastened roof panel
- ▶ Panel coverage: 12" or 16"
- ▶ 1" rib height
- ▶ Gauges: 26 ga. standard
- ▶ Minimum roof slope: 3:12
- ▶ Applies over solid substrate with 30# felt underlayment
- ▶ Finishes: MS Colorfast45®, PVDF and Acrylic Coated Galvalume®
- ▶ Contact Metal Sales for load-carrying capabilities



### Testing and Approvals

- ▶ UL 263, Fire Resistance Rating — per assembly
- ▶ UL 580, Class 90 Wind Uplift, Construction, #529
- ▶ UL 790, Class A Fire Resistance Rating — per assembly
- ▶ UL 2218, Class 4 Impact Resistance
- ▶ Miami-Dade County approved, NOA 18-0830.03
- ▶ Texas Department of Insurance Evaluation Reports, RC-162, RC-398 and RC-399
- ▶ ICC Evaluation Report, ESR-2385
- ▶ 2017 FBC Approved
  - 26 ga. over 5/8" Plywood, 11560.5
  - 26 ga. over 1/2" Plywood, 11560.4
  - 26 ga. over 7/16" OSB, 14645.12
  - 0.032" Aluminum over 7/16" OSB, 11560.2
  - 0.032" Aluminum over 5/8" Plywood, 11560.3

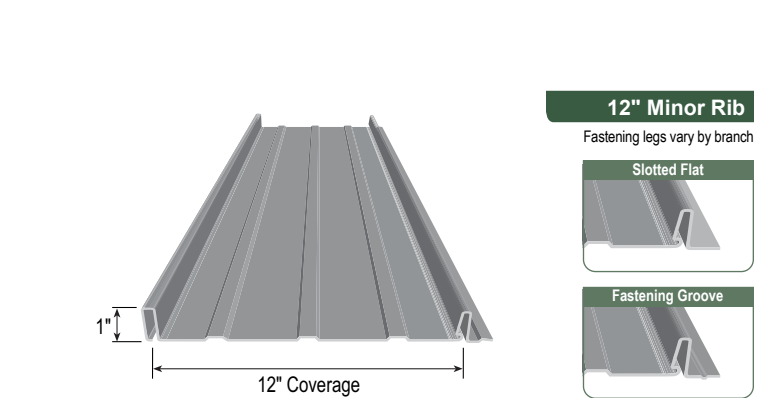
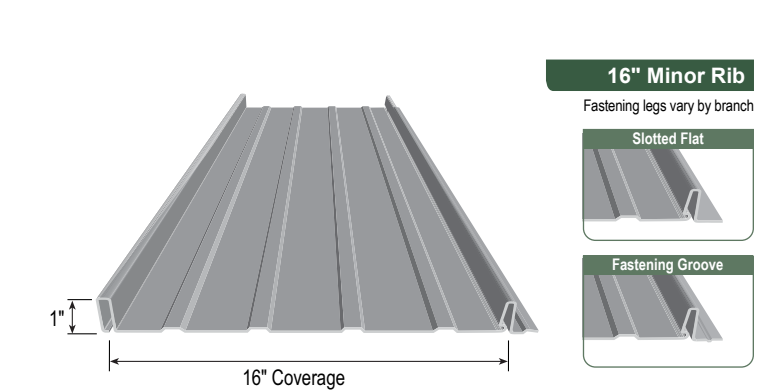
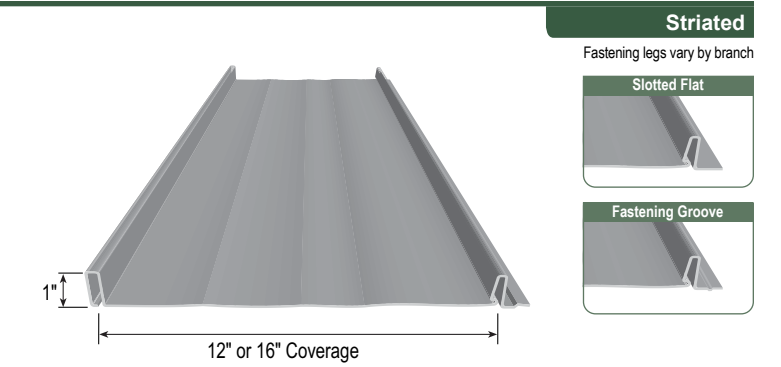

## Mini-Batten

- ▶ Architectural standing seam roof panel
- ▶ 12", 16" or 18" panel coverage, minimum roof slope: 3:12
- ▶ Mini-Batten offers, 1" & 1-1/2" high rib utilizing a narrow batten cap
- ▶ Gauges: 26 ga. and 24 ga. standard, 22 ga. optional
- ▶ Concealed clip designed for thermal movement
- ▶ Applies over solid substrate with 30# felt underlayment
- ▶ Finishes: PVDF, MS Colorfast45<sup>®</sup> and Acrylic Coated Galvalume<sup>®</sup>
- ▶ Contact Metal Sales for load-carrying capabilities

### Testing and Approvals

- ▷ UL 263, Fire Resistance Rating — per assembly
- ▷ UL 580, Class 90 Wind Uplift, Construction, #397, 397A and 430 (1" Mini-Batten)
- ▷ UL 580, Class 90 Wind Uplift, Construction, #352 (1-1/2" Mini-Batten)
- ▷ UL 790, Class A Fire Resistance Rating — per assembly
- ▷ UL 2218, Class 4 Impact Resistance
- ▷ ASTM E 283 Air Leakage
- ▷ ASTM E 331 Water Penetration

### Curved Mini-Batten

- ▶ Minimum radius 4'-0"

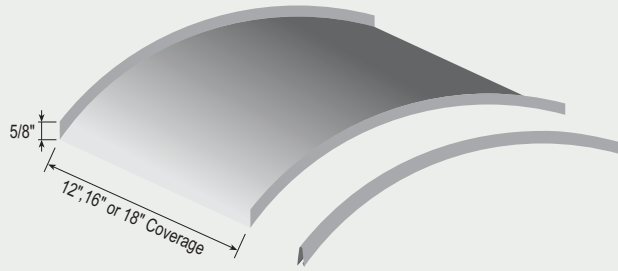

## Box-Batten/Maxi-Batten

- ▶ Architectural standing seam roof panel
- ▶ 12", 16", or 18" panel coverage, minimum roof slope: 3:12
- ▶ Maxi-Batten offers, 1-5/8" x 1-7/8"
- ▶ Box-Batten offers 1-1/2" x 1-1/2" cap
- ▶ Gauges: 26 ga. and 24 ga. standard, 22 ga. optional
- ▶ Concealed clip designed for thermal movement
- ▶ Applies over solid substrate with 30# felt underlayment
- ▶ Finishes: PVDF, MS Colorfast45<sup>®</sup> and Acrylic Coated Galvalume<sup>®</sup>
- ▶ Contact Metal Sales for load-carrying capabilities



### Testing and Approvals

- ▷ UL 263, Fire Resistance Rating — per assembly
- ▷ UL 580, Class 90 Wind Uplift, Construction, #398 and 398A (Maxi-Batten)
- ▷ UL 790, Class A Fire Resistance Rating — per assembly
- ▷ UL 2218, Class 4 Impact Resistance
- ▷ ASTM E 283 Air Leakage
- ▷ ASTM E 331 Water Penetration

### 1" Mini-Batten

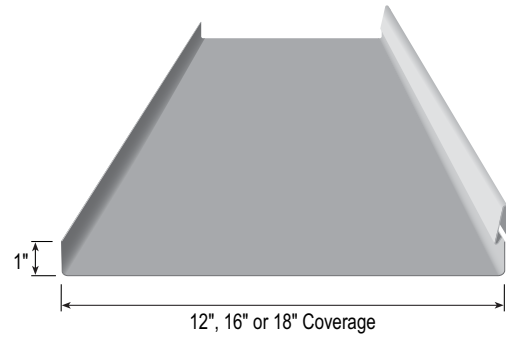

### 1.5" Mini-Batten

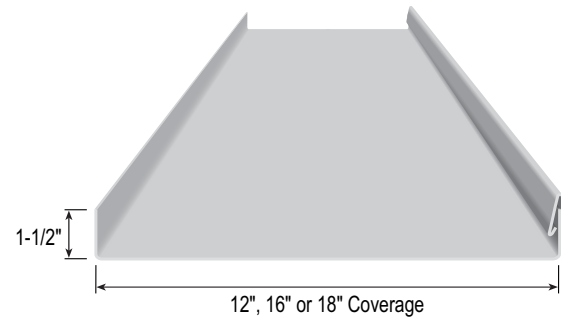

### Box-Batten

Available from Sellersburg, IN branch

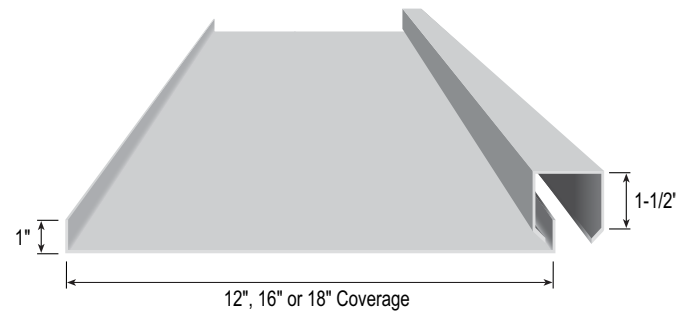

### Maxi-Batten

Available from Fontana, CA branch

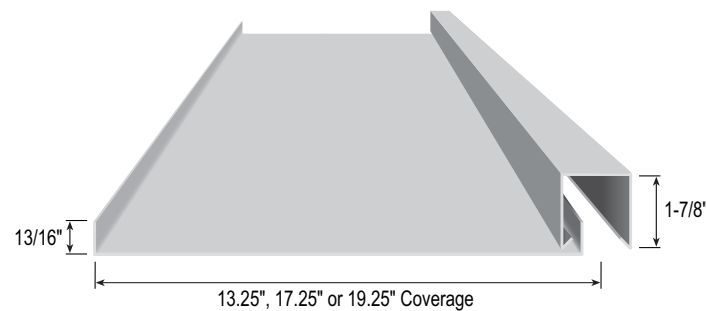

## TL-17 Series

- ▶ Concealed direct-fastened panel for wall, soffit, fascia or liner applications
- ▶ 12" panel coverage
- ▶ 1-1/2" panel depth
- ▶ 30'-0" maximum length, press-broke panel
- ▶ Gauges: 24 ga. standard, 22 ga., 20 ga. and 18 ga. optional
- ▶ Applies over open framing or solid substrate
- ▶ Finishes: PVDF and Acrylic Coated Galvalume<sup>®</sup>
- ▶ Optional material: stainless steel, aluminum and copper
- ▶ Custom capabilities include:
  - Perforated panels for wind screens and liner panels
- ▶ Optional Finishes: Multi-pass Kynar 500<sup>®</sup>, Marblique, Plastisol and Polyester
- ▶ Contact Metal Sales for load-carrying capabilities

TL-17 & TL-17D Wall



### Testing and Approvals

- ▷ UL 263, Fire Resistance Rating — per assembly
- ▷ ASTM E 283 Air Leakage
- ▷ ASTM E 330 Uniform Static Air Pressure Difference
- ▷ ASTM E 331 Water Penetration
- ▷ ASTM E 1592 Roof Uplift

### TL-17

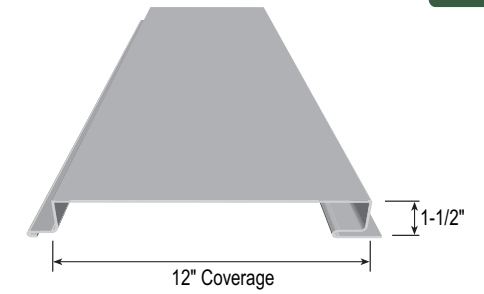

### TL-17A

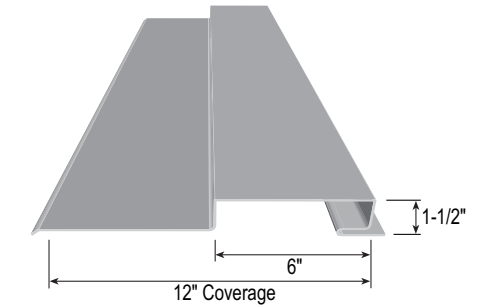

### TL-17C

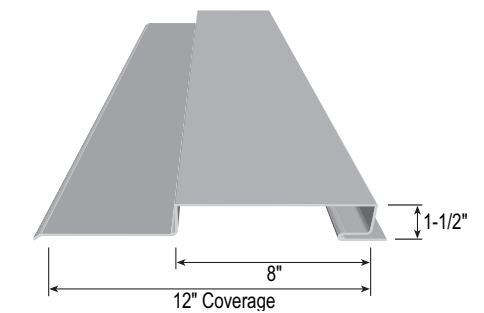

### TL-17D

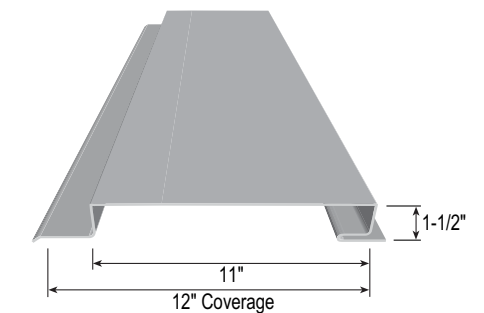

### TL-1222

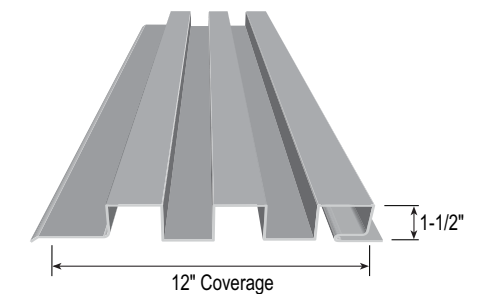

## Flush Face Series

- ▶ Concealed direct-fastened panel for wall, soffit, fascia or liner applications
- ▶ 12" panel coverage
- ▶ 1-1/2" panel depth
- ▶ 45'-0" maximum length, roll-formed panel
- ▶ Gauges: 24 ga. standard, 22 ga. and 20 ga. optional
- ▶ Applies over open framing or solid substrate
- ▶ Finishes: PVDF and Acrylic Coated Galvalume®
- ▶ Optional material: stainless steel, aluminum and copper
- ▶ Custom capabilities include:
  - Perforated panels for wind screens and liner panels
- ▶ Optional Finishes: Multi-pass Kynar 500®, Marblique, Plastisol and Polyester
- ▶ Contact Metal Sales for load-carrying capabilities



### Testing and Approvals

- ▶ UL 263, Fire Resistance Rating – per assembly
- ▶ ASTM E 283 Air Infiltration
- ▶ ASTM E 330 Uniform Static Air Pressure Difference
- ▶ ASTM E 331 Water Penetration
- ▶ ASTM E 1592 Roof Uplift

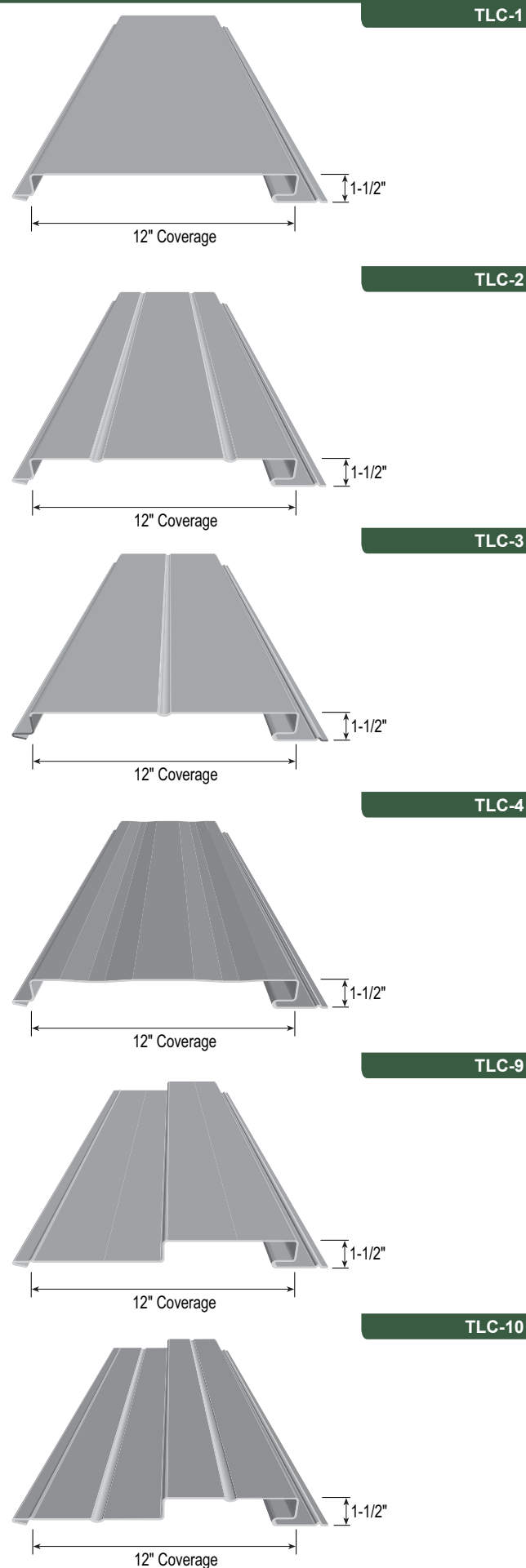

## Concealed Fastened Wall Panels

- ▶ Concealed direct-fastened panel for wall applications
- ▶ Panel lengths available from 5'-0" to 30'-0" max\*
- ▶ Gauges: 24 ga. standard; 22 ga. optional
- ▶ Applies over open framing or solid substrate
- ▶ Finishes: PVDF and Acrylic Coated Galvalume®
- ▶ Horizontal and Vertical installation
- ▶ Common joinery allows panel profile to be mixed and matched for increased design flexibility
- ▶ High-strength clip allows for thermal and seismic movement

\*Standard max length of 20' for AP1-1212, CN88-1212 and EM1-1212.

### Testing and Approvals

- ▶ ASTM E 283 Air Infiltration
- ▶ ASTM E 330 Load Testing
- ▶ ASTM E 331 Water Penetration
- ▶ ASTM E 1592 Roof Uplift

## Apex Series™ Symmetrical Rib

AP1-1212

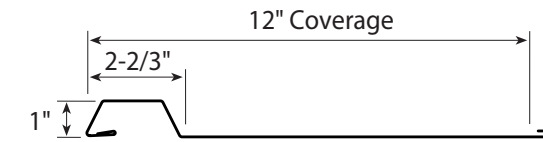

AP1-1653

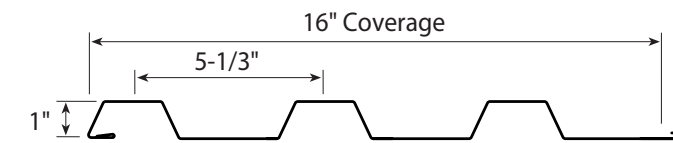

## Contempra Series™ Asymmetrical Rib

CN88-1212

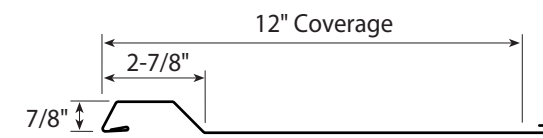

CN88-1653

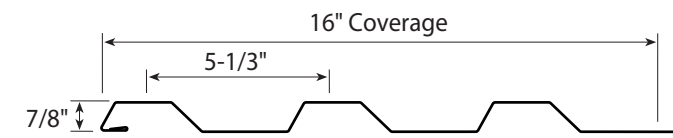

## Empire Series™

Box Rib

EM1-1212

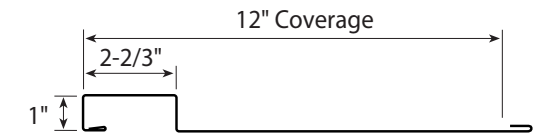

EM1-1653

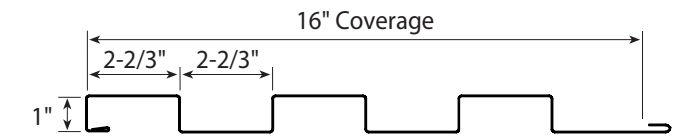

EM15-126

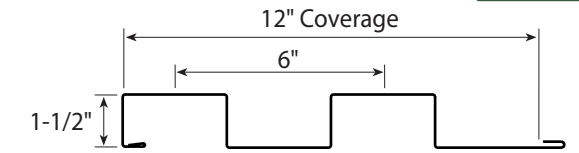

EM15-168

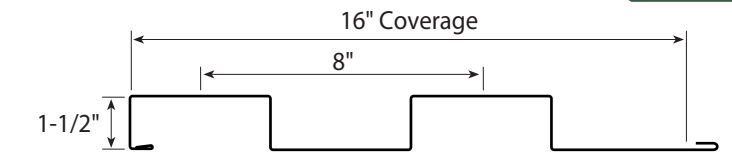

EM15-1266

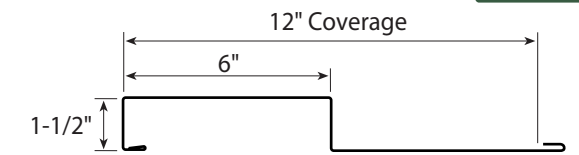

EM15-1275

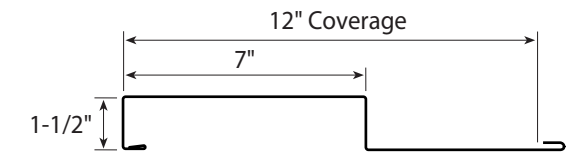

EM15-1284

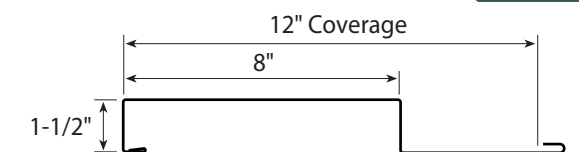

EM15-1293

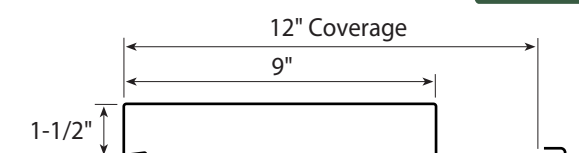

## Soffit Panel

- ▶ Concealed direct-fastened system for soffit, wall, fascia or liner applications
- ▶ 12" panel coverage
- ▶ 1" depth
- ▶ Max Panel Length: 26 ga. 5'-0", 24 ga. 20'-0" and 0.032" Alum 25'-0"
- ▶ Gauges: 26 ga., 24 ga. and 0.032" aluminum
- ▶ Lanced and Perforated versions are available
- ▶ Applies over solid substrate with 30# felt underlayment
- ▶ Finishes: MS Colorfast45®, PVDF and Acrylic Coated Galvalume®
- ▶ Contact Metal Sales for load-carrying capabilities

### Testing and Approvals

- ▷ UL 263, Fire Resistance Rating – per assembly
- ▷ ASTM E 283 Air Infiltration
- ▷ ASTM E 330 Uniform Static Air Pressure Difference
- ▷ ASTM E 331 Water Penetration
- ▷ 2017 FBC Approved
- 24 ga. panel over 16 ga. Purlins, 9482.5



### Perforated V-Grooves

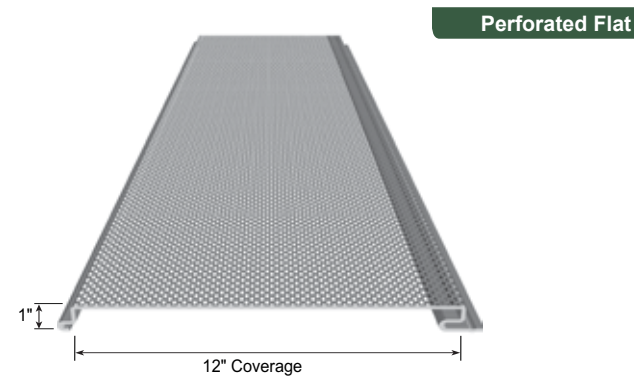
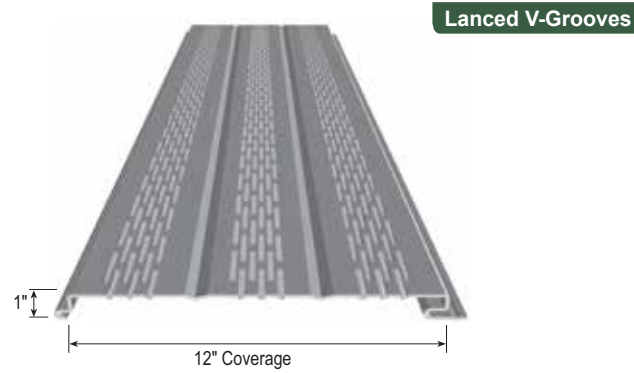
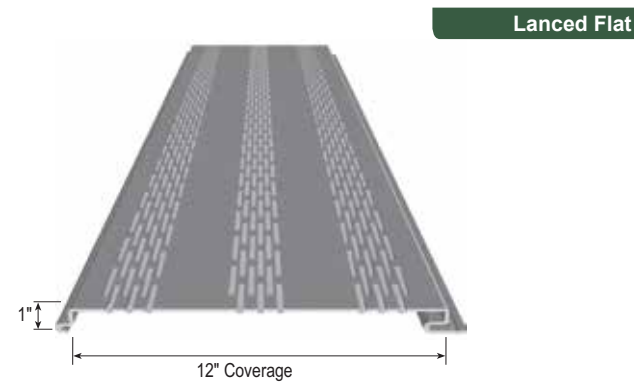
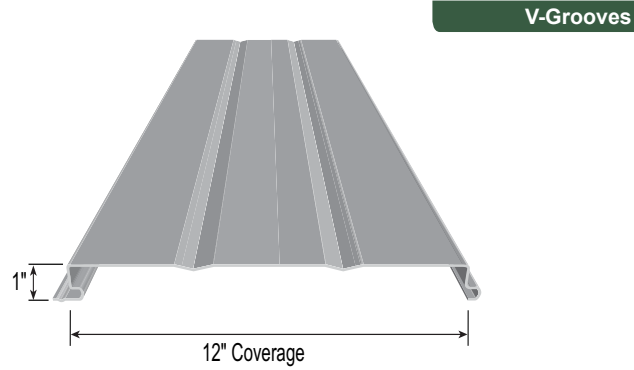
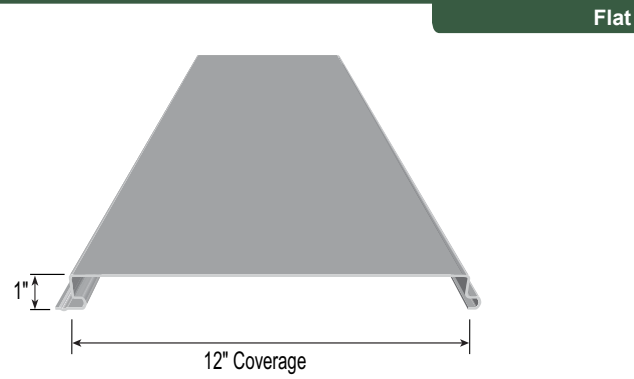
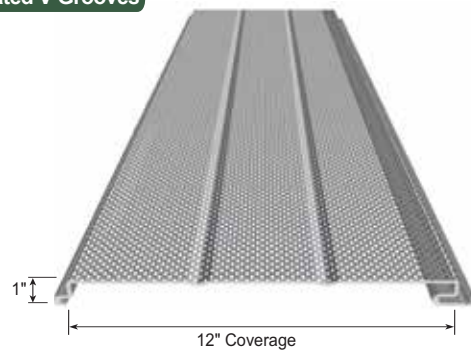

## T10 Series

- ▶ Exposed direct-fastened panel for wall, soffit, fascia and liner panel
- ▶ Applies over open framing or solid substrate
- ▶ 28", 30" and 36" panel coverages, 1-1/2" rib height
- ▶ 90° vertical box ribs on 4", 6", 9" and 12" centers
- ▶ Optional material: stainless steel, aluminum and copper
- ▶ Gauges: 24 ga. standard, 22 ga., 20 ga. and 18 ga. optional
- ▶ Custom capabilities include:
  - Perforated panels for wind screens and liner panels
  - Standard Finish: PVDF and Acrylic Coated Galvalume®
  - Optional Finishes: Multi-pass Kynar 500®, Marblique, Plastisol and Polyester
- ▶ Contact Metal Sales for load-carrying capabilities

Other profiles are available. Please inquire.



### Testing and Approvals

- ▷ UL 263, Fire Resistance Rating – per assembly
- ▷ UL 2218, Class 4 Impact Rating

### T10-A Wall Panel

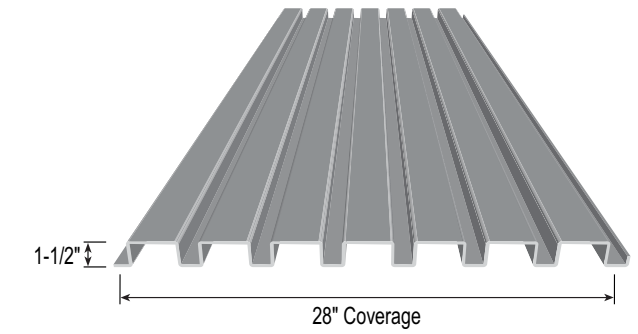

### T10-B Wall Panel

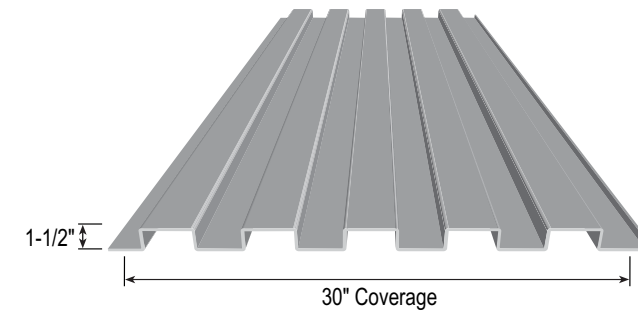

### T10-C Wall Panel

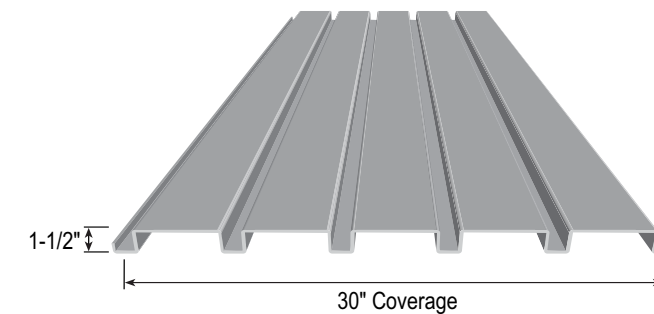

### T10-D Wall Panel

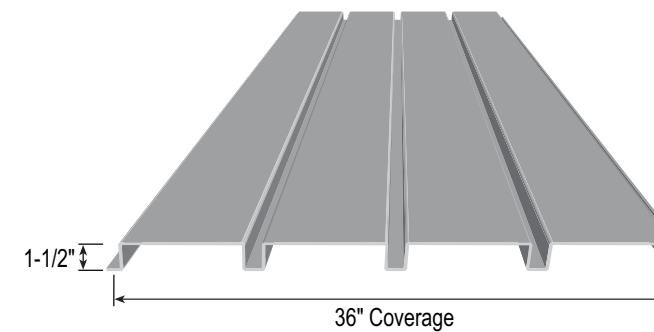

## 7/8" Corrugated

- ▶ Exposed direct-fastened panel for roof and wall applications
- ▶ 32" roof coverage (34-2/3" wall coverage)
- ▶ 7/8" rib height, 2-2/3" centers
- ▶ Gauges: 26 ga. and 24 ga. standard, 22 ga. and 20 ga. optional
- ▶ Optional materials: stainless steel, aluminum, copper and weathering steel
- ▶ Minimum roof slope: 1:12
- ▶ Applies over open framing or solid substrate
- ▶ Finishes: MS Colorfast45®, PVDF and Acrylic Coated Galvalume®
- ▶ Contact Metal Sales for load-carrying capabilities

### Testing and Approvals

- ▶ UL 263, Fire Resistance Rating – per assembly
- ▶ UL 790, Class A Fire Resistance Rating – per assembly
- ▶ UL 2218, Class 4 Impact Resistance
- ▶ ASTM E 283 Air Infiltration
- ▶ ASTM E 330 Uniform Static Air Pressure Difference
- ▶ ASTM E 331 Water Penetration
- ▶ ASTM E 1592 Roof Uplift Capacity
- ▶ ASTM E 1646 Water Penetration
- ▶ ASTM E 1680 Air Leakage
- ▶ Texas Department of Insurance Evaluation Report, RC-409
- ▶ ICC Evaluation Report, ESR-2385
- ▶ 2017 FBC Approved
  - 24 ga. roof panel over 16 ga. Purlins, 10999.1
  - 24 ga. wall panel over 16 ga. Girts, 9482.1

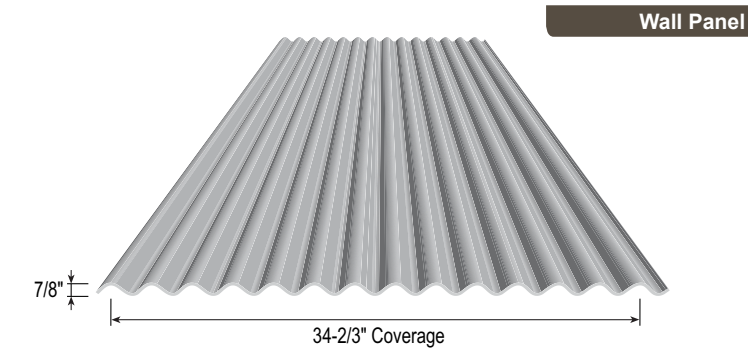
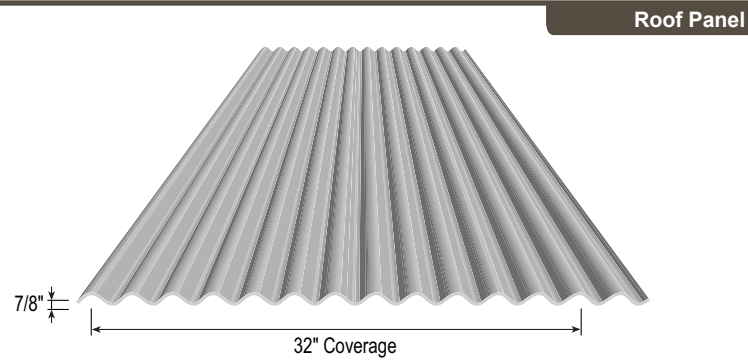

## 5V-Crimp

- ▶ Exposed direct-fastened roof panel, traditional "V" rib
- ▶ 24" panel coverage
- ▶ 1/2" rib height
- ▶ Gauges: 29 ga. and 26 ga. standard, 0.032" Aluminum optional
- ▶ Minimum roof slope: 3:12
- ▶ Applies over solid substrate with 30# felt underlayment
- ▶ Finishes: MS Colorfast45® and Acrylic Coated Galvalume®
- ▶ Contact Metal Sales for load-carrying capabilities

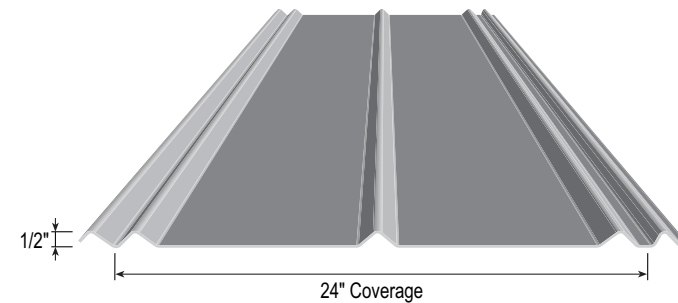

### Testing and Approvals

- ▶ UL 263, Fire Resistance Rating – per assembly
- ▶ UL 580, Class 90 Wind Uplift, Construction, #453 and 579
- ▶ UL 790, Class A Fire Resistance Rating – per assembly
- ▶ UL 2218, Class 4 Impact Rating
- ▶ Miami-Dade County Approved, NOA 18-0313.02 (26 gauge)
- ▶ Miami-Dade County Approved, NOA 14-1227.02 (0.032" Aluminum)
- ▶ Texas Department of Insurance Evaluation Report, RC-160
- ▶ 2017 FBC Approved
  - 26 ga. over 5/8" Plywood, 14645.2 and 14645.3
  - 26 ga. over 7/16" OSB, 14645.4
  - 0.032" Aluminum over 7/16" OSB, 11560.1



## IC72-Panel

- ▶ Exposed direct-fastened industrial panel
- ▶ Roof and wall applications
- ▶ 36" panel coverage, minimum roof slope: 1:12
- ▶ 1-1/2" rib height at 7.2" centers
- ▶ Gauges: 24 ga. standard, 22 ga. and 20 ga. optional
- ▶ Applies over open framing or solid substrate
- ▶ Finishes: PVDF and Acrylic Coated Galvalume®
- ▶ Contact Metal Sales for load-carrying capabilities



### Testing and Approvals

- ▶ UL 263, Fire Resistance Rating – per assembly
- ▶ UL 790, Class A Fire Resistance Rating – per assembly
- ▶ ASTM E 283 Air Infiltration
- ▶ ASTM E 330 Uniform Static Air Pressure Difference
- ▶ ASTM E 331 Water Penetration
- ▶ ICC Evaluation Report, ESR-2385

## V-Line 32

- ▶ Exposed direct-fastened panel for roof and wall applications
- ▶ 32" panel coverage
- ▶ Trapezoidal rib on 4-9/16" centers
- ▶ 1-3/8" rib height
- ▶ Gauges: 26 ga. and 24 ga. standard, 22 ga. optional
- ▶ Minimum roof slope: 1:12
- ▶ Applies over open framing or solid substrate
- ▶ Finishes: MS Colorfast45®, PVDF and Acrylic Coated Galvalume®
- ▶ Contact Metal Sales for load-carrying capabilities

### Testing and Approvals

- ▶ UL 263, Fire Resistance Rating – per assembly
- ▶ UL 580, Class 90 Wind Uplift, Construction, #187
- ▶ UL 790, Class A Fire Resistance Rating – per assembly
- ▶ UL 2218, Class 4 Impact Resistance

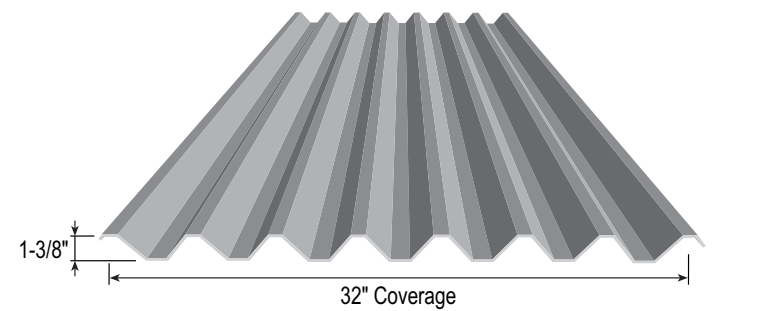
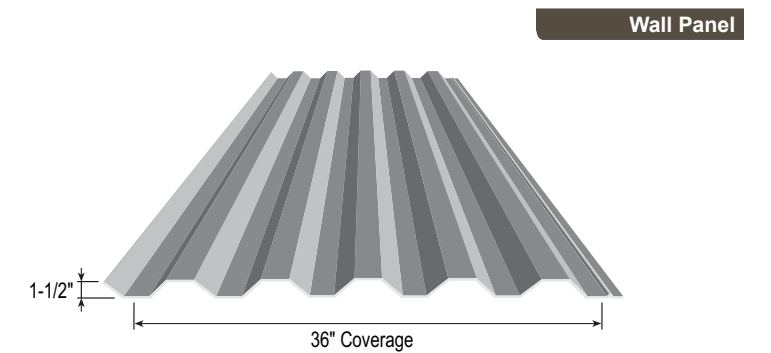
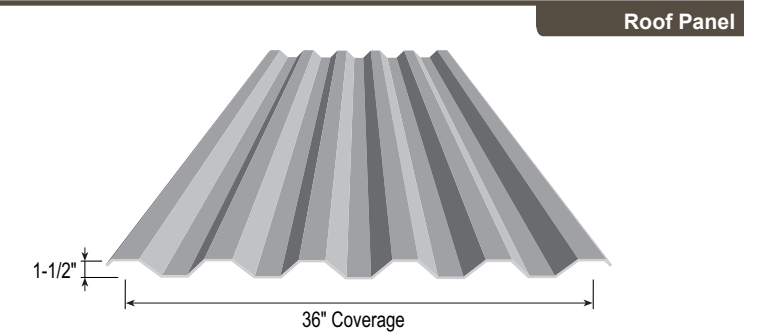



# Exposed Fastened Series

- ▶ Exposed direct-fastened panel for roof and wall applications
- ▶ Applies over open framing or solid substrate
- ▶ Panel coverage: 32" to 44"
- ▶ Rib height: 5/8" to 1-3/4"
- ▶ Optional material: stainless steel, aluminum and copper
- ▶ Gauges: 24 ga. standard, 22 ga., 20 ga. and 18 ga. optional
- ▶ Minimum roof slope: 1:12
- ▶ Standard Finish: PVDF and Acrylic Coated Galvalume®
- ▶ Optional Finishes: Multi-pass Kynar 500®, Marblique, Plastisol and Polyester
- ▶ Contact Metal Sales for load-carrying capabilities

Other profiles are available. Please inquire.



T2630 Panel



T1 Roof

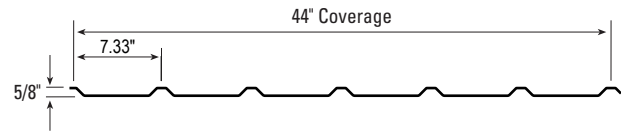

T1 Wall

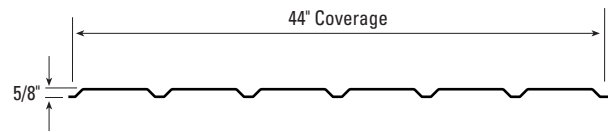

T2 Roof

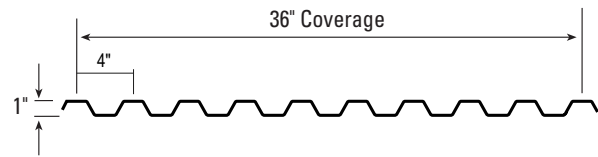

T2 Wall

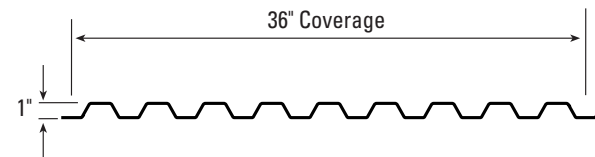

T3 Roof

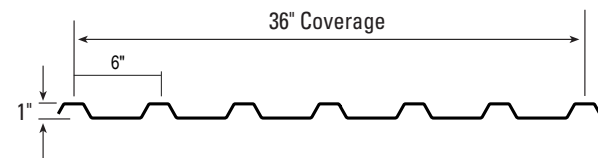

T3 Wall

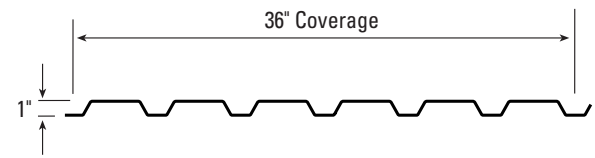

T4 Roof

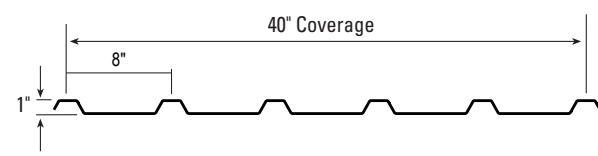

T4 Wall

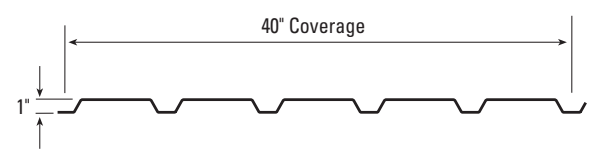

T5 Roof

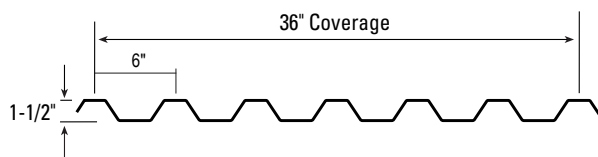

T5 Wall

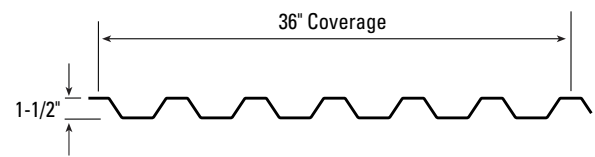

T5, T6-A Wall

T6-A Roof

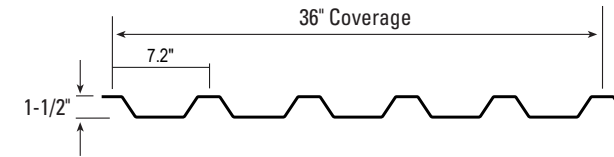

T6-A Wall

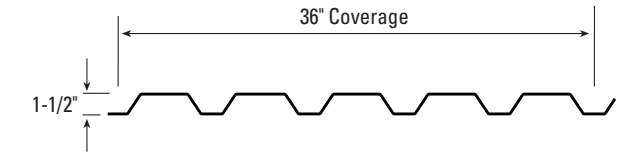

T7 Roof

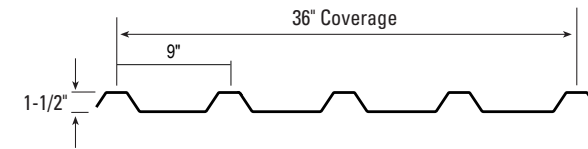

T7 Wall

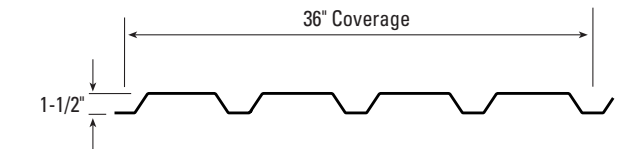

T7-A Roof

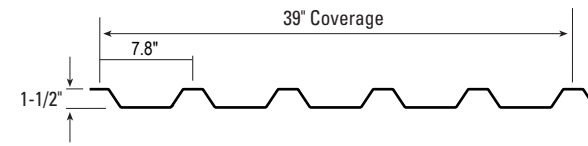

T7-A Wall

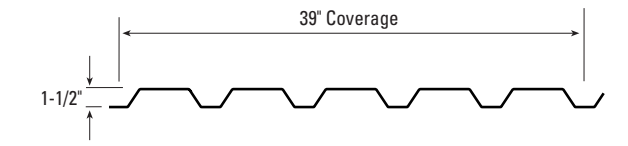

T11-A Roof

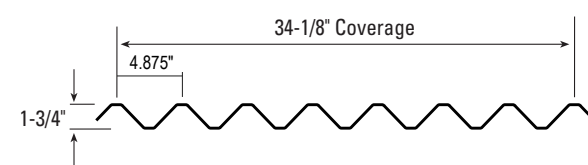

T11-A Wall

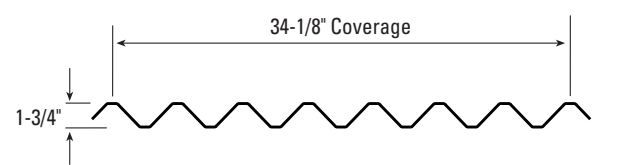

T12 Roof/Wall

Same profile for Roof and Wall

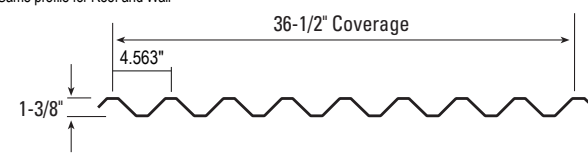

T16-L Wall

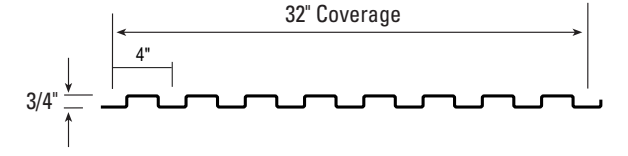

T16-E Roof

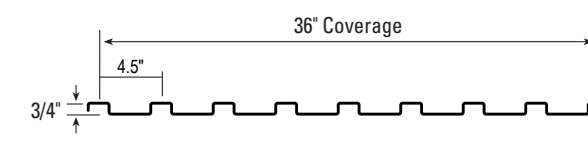

T16-E Wall

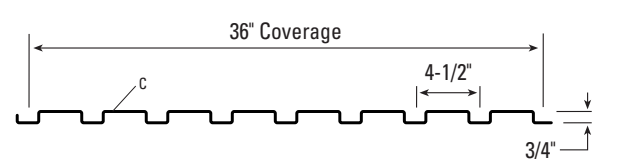

## Deep Rib Series

- ▶ Exposed direct-fastened panel for roof and wall applications
- ▶ Applies over open framing or solid substrate
- ▶ Various panel coverages
- ▶ 2", 4" and 4-1/2" rib heights
- ▶ Trapezoidal ribs on various centers
- ▶ Optional material: stainless steel, aluminum and copper
- ▶ Gauges: 24 ga. standard, 22 ga., 20 ga. and 18 ga. optional
- ▶ Minimum roof slope: 1:12
- ▶ Custom capabilities include:
  - Perforated panels for wind screens and liner panels
- ▶ Standard Finish: PVDF and Acrylic Coated Galvalume®
- ▶ Optional Finishes: Multi-pass Kynar 500®, Marblique, Plastisol and Polyester
- ▶ Contact Metal Sales for load-carrying capabilities

Other profiles are available. Please inquire.

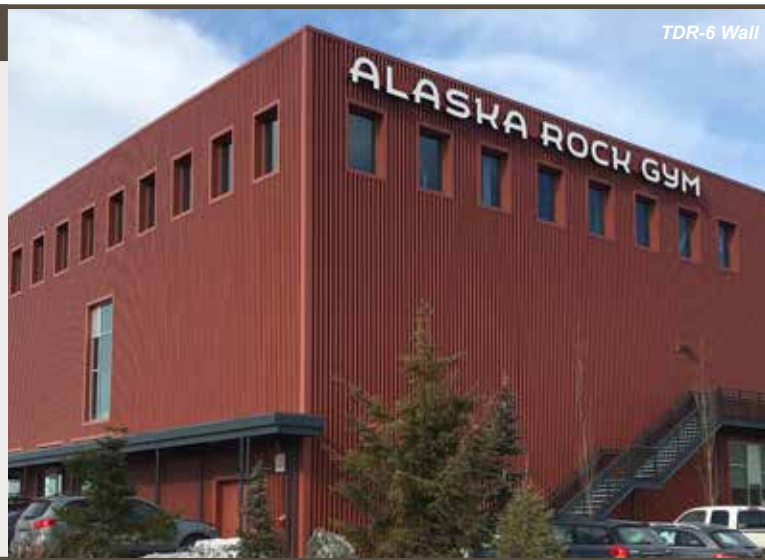

TDR-6 Wall

T2630 Roof

T2630 Wall

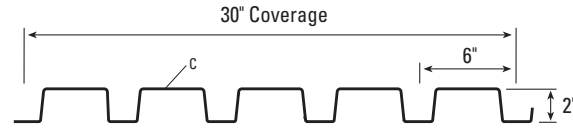
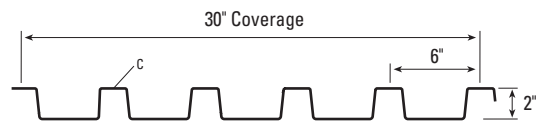

T2832 Roof

T2832 Wall

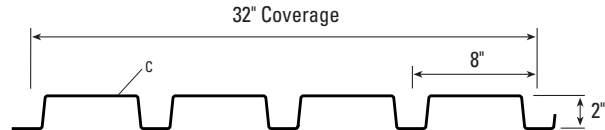
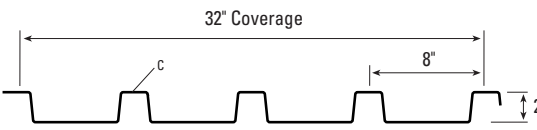

T15 Roof

T15 Wall

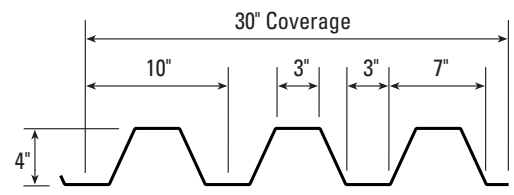
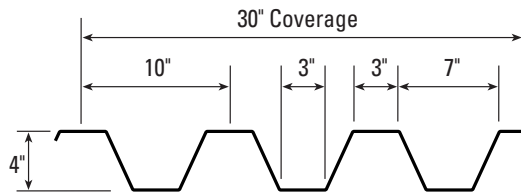

T25 Roof

T25 Wall

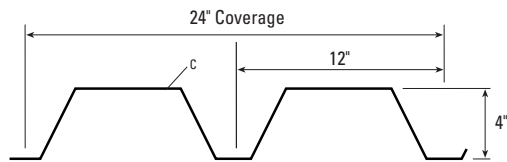
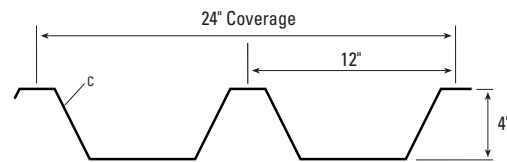

TDR-6 Roof

TDR-6 Wall

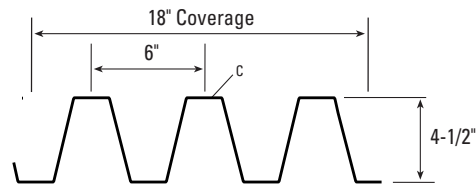
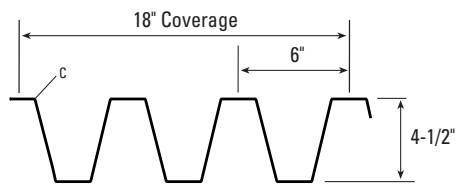

## Industrial Rib Series

- ▶ Exposed direct-fastened panel for roof and wall applications
- ▶ Applies over open framing or solid substrate
- ▶ 24" and 30" panel coverages
- ▶ 3" and 3-1/2" rib heights
- ▶ Trapezoidal ribs on various centers
- ▶ Optional material: stainless steel, aluminum and copper
- ▶ Gauges: 24 ga. standard, 22 ga., 20 ga. and 18 ga. optional
- ▶ Minimum roof slope: 1:12
- ▶ Custom capabilities include:
  - Perforated panels for wind screens and liner panels
- ▶ Standard Finish: PVDF and Acrylic Coated Galvalume®

Other profiles are available. Please inquire.



T13-B Wall

T13 Roof

T13 Wall

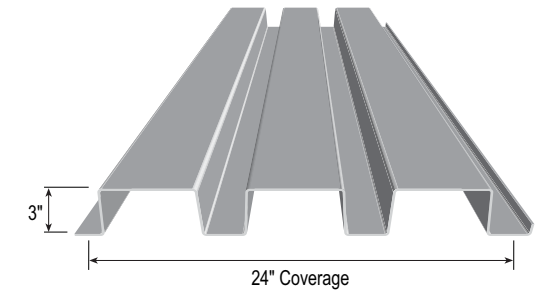
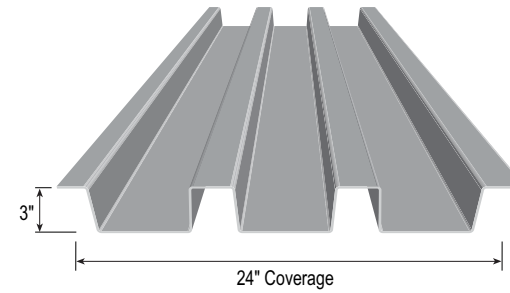

T13-A Roof

T13-A Wall

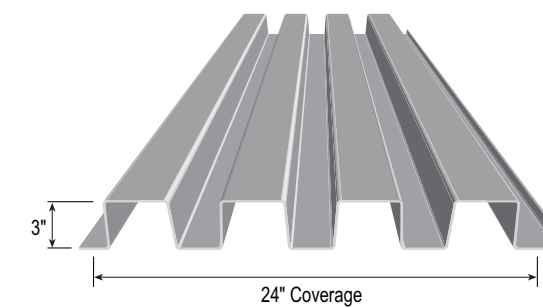
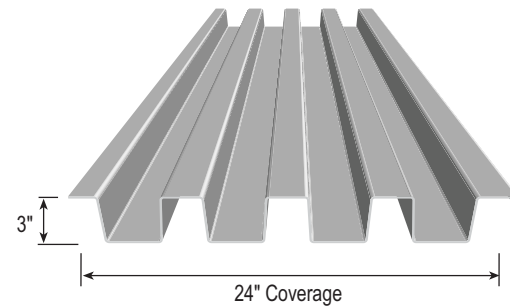

T13-B Roof

T13-B Wall

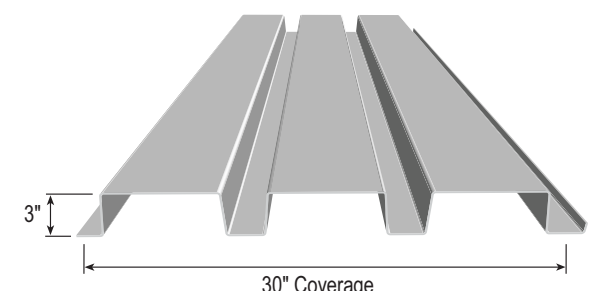
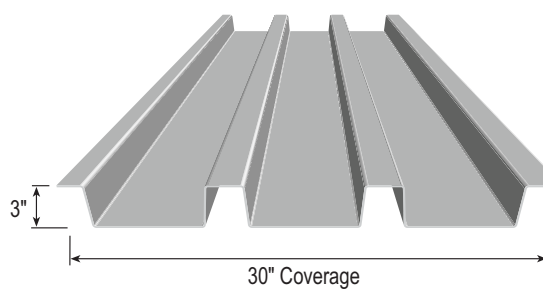

T14 Roof

T14 Wall

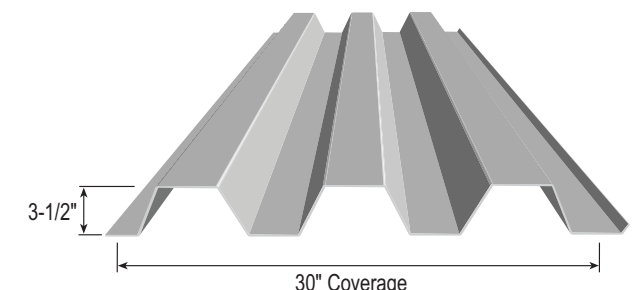
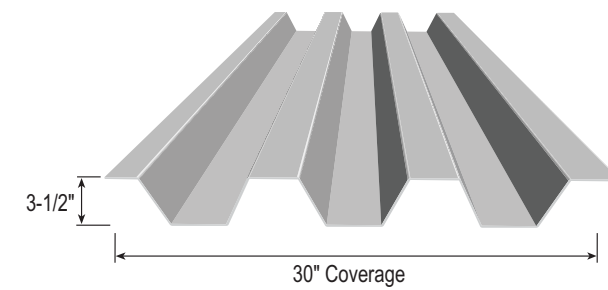

## PBR-Panel, R-Panel

- ▶ Exposed direct-fastened panel for roof and wall applications
- ▶ 36" panel coverage
- ▶ Trapezoidal rib on 12" centers
- ▶ 1-1/4" rib height
- ▶ PBR-Panel Gauges: 26 ga. and 24 ga. standard, 22 ga. optional
- ▶ R-Panel Gauges: 26 ga. standard
- ▶ Minimum roof slope: 1:12
- ▶ Applies over open framing or solid substrate
- ▶ Finishes: MS Colorfast45®, PVDF and Acrylic Coated Galvalume®
- ▶ Contact Metal Sales for load-carrying capabilities

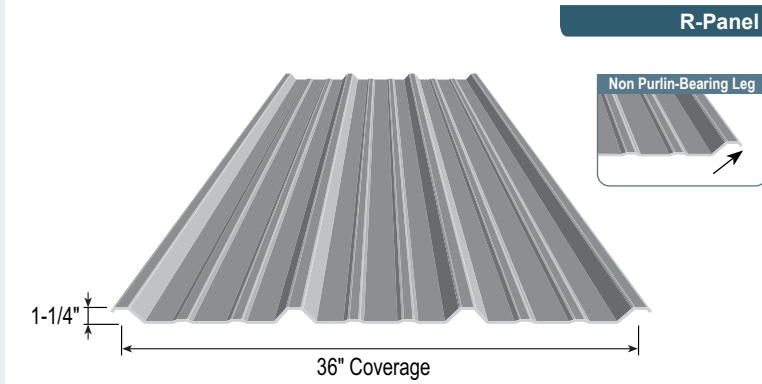
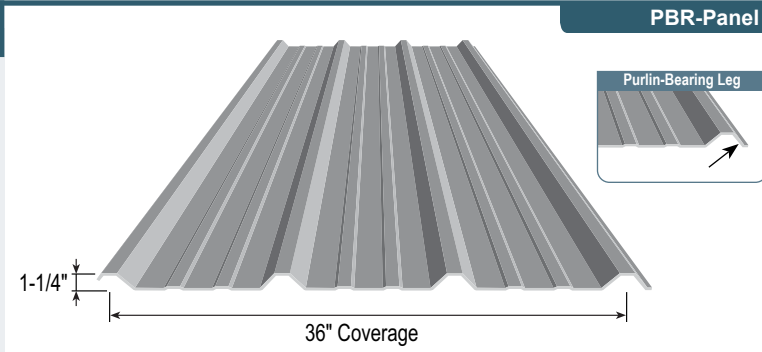

### Testing and Approvals

- ▶ UL 580, Class 90 Wind Uplift, Construction, #161
- ▶ UL 790, Class A Fire Resistance Rating – per assembly
- ▶ UL 2218, Class 4 Impact Resistance
- ▶ ASTM E 455 Diaphragm Test
- ▶ Miami-Dade County Approved, NOA 18-0131.05 and 18-0131.04 (24 ga. roof & wall)
- ▶ Texas Department of Insurance Evaluation Reports, RC-198, RC-265, RC-279, RC-391
- ▶ ICC Evaluation Report, ESR-2385 (R-Panel)
- ▶ 2017 FBC Approved
  - 26 ga. over 16 ga. Purlins, 10999.7
  - 26 ga. over 16 ga. Girts, 9482.4
  - 26 ga. over 1/2" Plywood, 14645.12



## PBU-Panel, U-Panel

- ▶ Exposed direct-fastened panel for roof and wall applications
- ▶ 36" panel coverage
- ▶ Trapezoidal rib on 6" centers
- ▶ 3/4" rib height
- ▶ Gauges: 29 ga., 26 ga. and 24 ga. standard, 22 ga. optional
- ▶ Minimum roof slope: 1:12
- ▶ Applies over open framing or solid substrate
- ▶ Finishes: MS Colorfast45®, PVDF and Acrylic Coated Galvalume®
- ▶ Contact Metal Sales for load-carrying capabilities

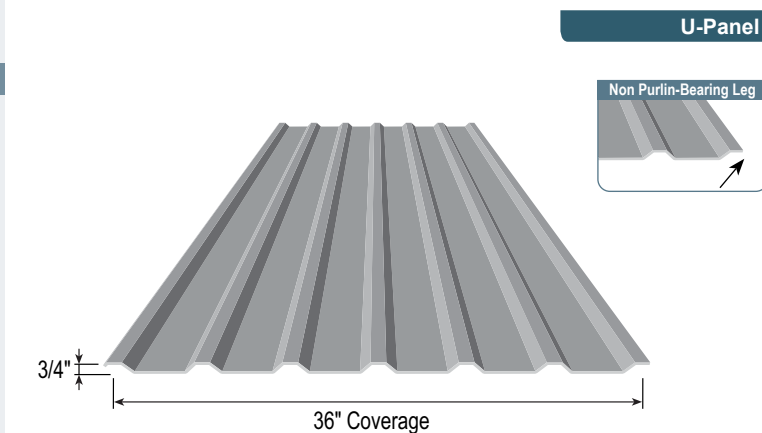
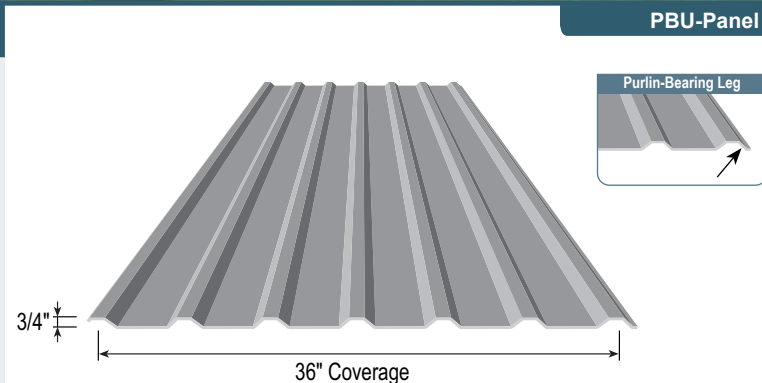

### Testing and Approvals

- ▶ UL 263, Fire Resistance Rating – per assembly
- ▶ UL 580, Class 90 Wind Uplift, Construction, #39
- ▶ UL 790, Class A Fire Resistance Rating – per assembly
- ▶ UL 2218, Class 4 Impact Resistance
- ▶ Texas Department of Insurance Evaluation Report, RC-196
- ▶ ICC Evaluation Report, ESR-2385

## Pro-Panel II®

- ▶ Exposed direct-fastened, low profile panel for roof and wall
- ▶ 36" panel coverage
- ▶ Trapezoidal rib on 9" centers
- ▶ 5/8" rib height
- ▶ Gauges: 29 ga. and 26 ga. standard
- ▶ Minimum roof slope: 3:12
- ▶ Applies over open framing or solid substrate
- ▶ Finishes: MS Colorfast45®, PVDF and Acrylic Coated Galvalume®
- ▶ Contact Metal Sales for load-carrying capabilities

### Testing and Approvals

- ▶ UL 263, Fire Resistance Rating – per assembly
- ▶ UL 790, Class A Fire Resistance Rating – per assembly
- ▶ UL 2218, Class 4 Impact Resistance
- ▶ ASTM E 455 Diaphragm Test
- ▶ 2017 FBC Approved
  - 29 ga. over 1/2" Plywood, 14645.14

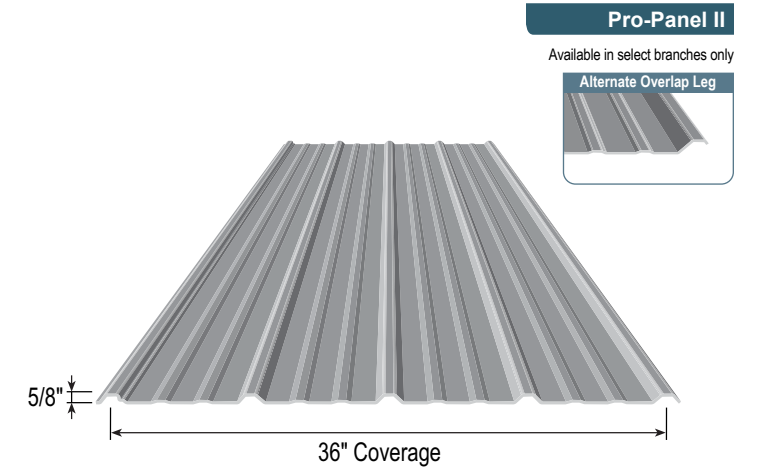
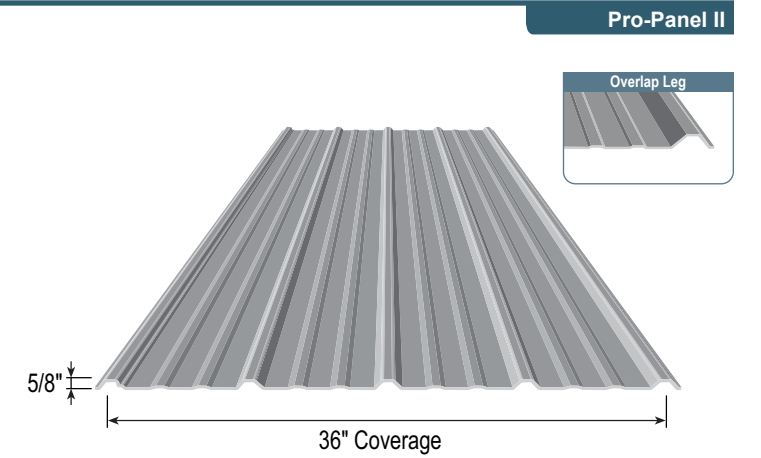

### Pro-Panel II

Available in select branches only

## Classic Rib®

- ▶ Exposed direct-fastened, low profile panel for roof and wall
- ▶ 36" panel coverage
- ▶ Trapezoidal rib on 9" centers
- ▶ 3/4" bell-top rib height
- ▶ Gauges: 29 ga. and 26 ga. standard
- ▶ Minimum roof slope: 3:12
- ▶ Applies over open framing or solid substrate
- ▶ Finishes: MS Colorfast45®, PVDF and Acrylic Coated Galvalume®
- ▶ Contact Metal Sales for load-carrying capabilities

### Testing and Approvals

- ▶ UL 263, Fire Resistance Rating – per assembly
- ▶ UL 580, Class 90 Wind Uplift, Construction, #560 and 584
- ▶ UL 790, Class A Fire Resistance Rating – per assembly
- ▶ UL 2218, Class 4 Impact Resistance
- ▶ ASTM E 455 Diaphragm Test
- ▶ ASTM E 564-95 Diaphragm Test
- ▶ Miami-Dade County Approved, NOA 16-0218.02
- ▶ Texas Department of Insurance Evaluation Reports, RC-161 and RC-391
- ▶ ICC Evaluation Report, ESR-2385
- ▶ 2017 FBC Approved
  - 29 ga. over 2x Purlins, 10999.4
  - 29 ga. over 2x Girts, 9482.3
  - 29 ga. over 7/16" OSB, 14645.10
  - 29 ga. over 1/2" Plywood, 14145.13
  - 29 ga. over 1/2" Plywood, 14645.8
  - 26 ga. over 5/8" Plywood, 14645.9
  - 26 ga. over 16 ga. Girts, 9482.2
  - 26 ga. over 16 ga. Purlins, 10999.3
  - 0.032" Aluminum over 7/16" OSB, 14645.5

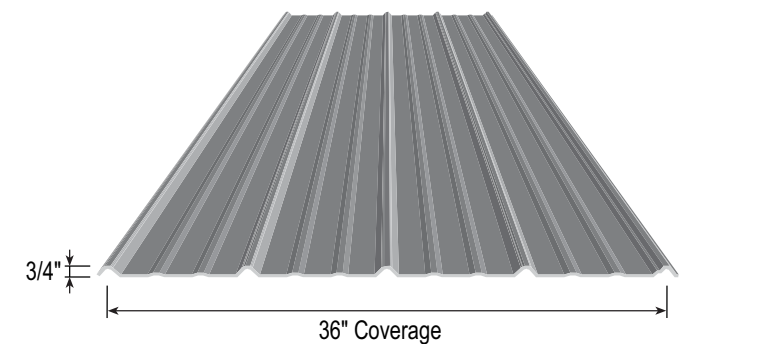

## 1.25" Corrugated

- ▶ Exposed direct-fastened panel for roof and wall applications
- ▶ 24" panel coverage
- ▶ Corrugated ribs on 1-1/4" centers
- ▶ 1/4" rib height
- ▶ Gauges: 29 ga. and 26 ga. standard
- ▶ Minimum roof slope: 3:12
- ▶ Applies over open framing or solid substrate
- ▶ Finishes: MS Colorfast45® and Acrylic Coated Galvalume®
- ▶ Contact Metal Sales for load-carrying capabilities

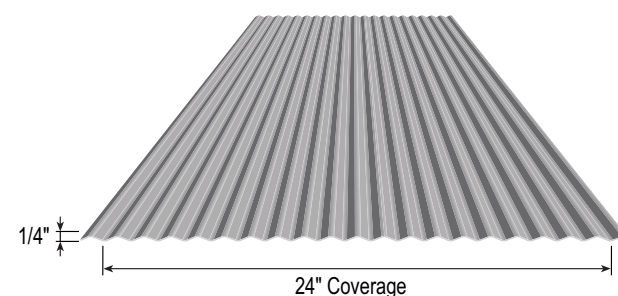

### Testing and Approvals

- ▶ UL 263, Fire Resistance Rating – per assembly
- ▶ UL 580, Class 90 Wind Uplift, Construction, #161
- ▶ UL 790, Class A Fire Resistance Rating – per assembly
- ▶ UL 2218, Class 4 Impact Resistance



Roof

## 2.5" Corrugated

- ▶ Exposed direct-fastened panel for roof and wall applications
- ▶ 24" panel coverage (wall)
- ▶ 21-1/3" panel coverage (roof)
- ▶ Corrugated ribs on 2-2/3" centers
- ▶ 1/2" rib height
- ▶ Gauges: 29 ga. and 26 ga. standard
- ▶ Minimum roof slope: 3:12
- ▶ Applies over open framing or solid substrate
- ▶ Finishes: MS Colorfast45® and Acrylic Coated Galvalume®
- ▶ Contact Metal Sales for load-carrying capabilities

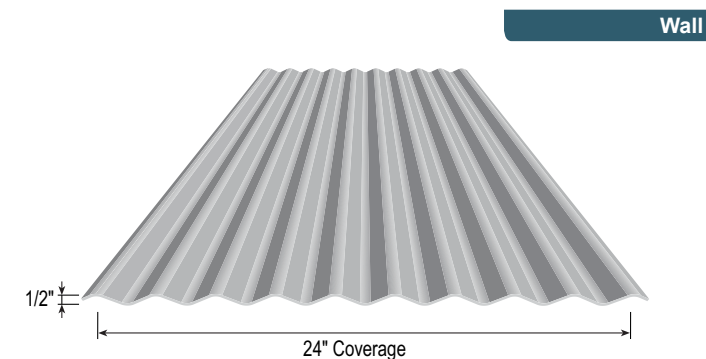
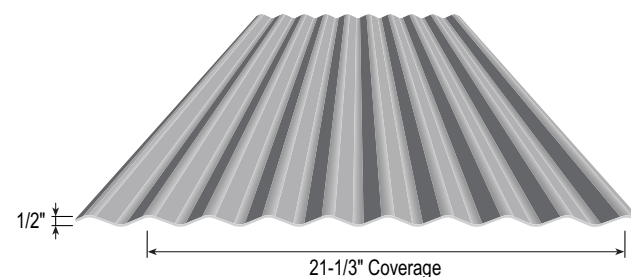

Wall

### Testing and Approvals

- ▶ UL 263, Fire Resistance Rating – per assembly
- ▶ UL 790, Class A Fire Resistance Rating – per assembly
- ▶ UL 2218, Class 4 Impact Resistance
- ▶ Texas Department of Insurance Evaluation Report, RC-159
- ▶ ICC Evaluation Report, ESR-2385
- ▶ 2017 FBC Approved
- ▶ -26 ga. over 5/8" Plywood, 14645.1



## Strongpanel

- ▶ Exposed direct-fastened roof and wall panel
- ▶ 36" panel coverage
- ▶ 5/8" rib height
- ▶ Classic board and batten design, on 9" centers
- ▶ Gauges: 29 ga. and 28 ga. standard
- ▶ Minimum roof slope: 3:12
- ▶ Applies over open framing or solid substrate
- ▶ Finishes: MS Strongcoat45® and Galvanized
- ▶ Contact Metal Sales for load-carrying capabilities

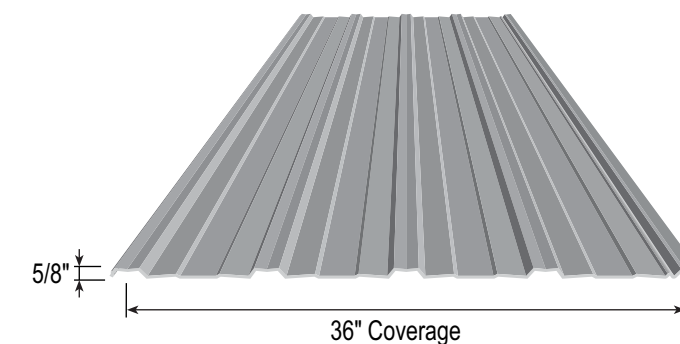

### Testing and Approvals

- ▶ UL 263, Fire Resistance – per assembly
- ▶ UL 580, Class 90 Wind Uplift, Construction, #161
- ▶ UL 790, Class A Fire Resistance Rating – per assembly
- ▶ UL 2218, Class 4 Impact Resistance
- ▶ Texas Department of Insurance, RC-405 and RC-406



## Span-Line 36A

- ▶ Exposed direct-fastened wall panel
- ▶ 36" panel coverage
- ▶ 1-1/8" rib height
- ▶ Inverted trapezoidal ribs on 12" centers
- ▶ Gauges: 26 ga. and 24 ga. standard, 22 ga. optional
- ▶ Applies over open framing or solid substrate
- ▶ Finishes: MS Colorfast45®, PVDF and Acrylic Coated Galvalume®
- ▶ Contact Metal Sales for load-carrying capabilities

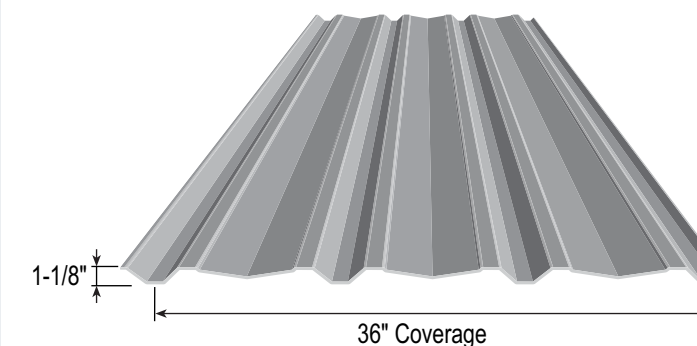

### Testing and Approvals

- ▶ UL 263, Fire Resistance Rating – per assembly
- ▶ UL 2218, Class 4 Impact Resistance
- ▶ ASTM E 330 Uniform Static Air Pressure Difference
- ▶ 2017 FBC Approved
- ▶ -26 ga. over 16 ga. Girts, 9482.6



## DL-3 Panel

- ▶ Exposed direct-fastened panel for roof and wall applications
- ▶ 36" panel coverage
- ▶ 1/2" rib height
- ▶ Trapezoidal ribs on 3" centers
- ▶ Gauges: 29 ga. standard
- ▶ Minimum roof slope: 3:12
- ▶ Applies over open framing or solid substrate
- ▶ Finishes: MS Colorfast45® and Bare Galvanized
- ▶ Contact Metal Sales for load-carrying capabilities

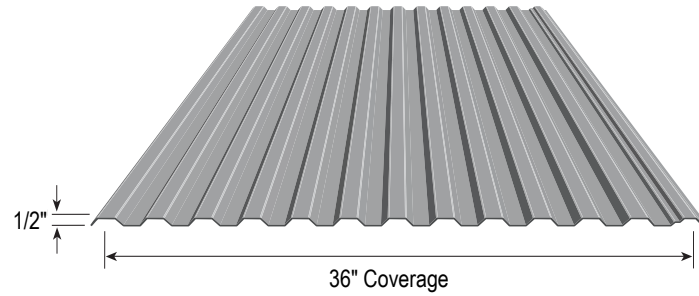

### Testing and Approvals

- ▶ ASTM E 1592 Structural Performance

## Bi-Rib

- ▶ Exposed direct-fastened panel for roof and wall applications
- ▶ 36" panel coverage
- ▶ 7/16" rib height
- ▶ Double trapezoidal ribs on 9" centers
- ▶ Gauges: 29 ga. and 26 ga. standard
- ▶ Minimum roof slope: 3:12
- ▶ Applies over open framing or solid substrate
- ▶ Finishes: MS Colorfast45® and Acrylic Coated Galvalume®
- ▶ Contact Metal Sales for load-carrying capabilities

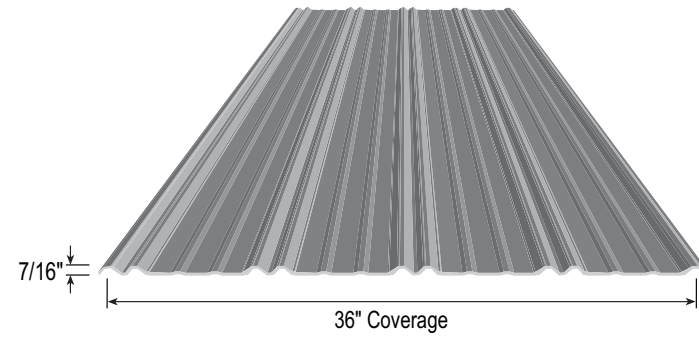

### Testing and Approvals

- ▶ UL 263, Fire Resistance – per assembly
- ▶ UL 790, Class A Fire Resistance Rating – per assembly
- ▶ UL 2218, Class 4 Impact Resistance

## Delta Rib

- ▶ Exposed direct-fastened panel for roof and wall applications
- ▶ 24" panel coverage
- ▶ 13/16" rib height
- ▶ Trapezoidal rib on 8" centers
- ▶ Gauges: 29 ga. and 26 ga. standard
- ▶ Minimum roof slope: 3:12
- ▶ Applies over open framing or solid substrate
- ▶ Finishes: MS Colorfast45® and Acrylic Coated Galvalume®
- ▶ Contact Metal Sales for load-carrying capabilities

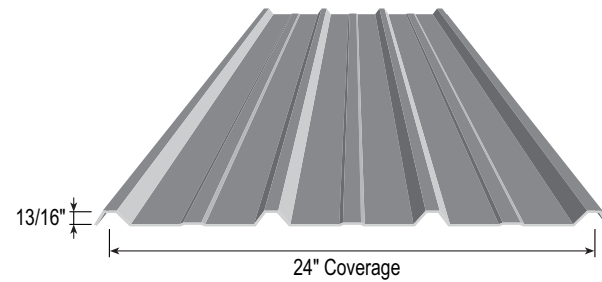

### Testing and Approvals

- ▶ UL 263, Fire Resistance Rating – per assembly
- ▶ UL 790, Class A Fire Resistance Rating – per assembly
- ▶ UL 2218, Class 4 Impact Resistance

## Dual Rib

- ▶ Mill-finished diamond-embossed aluminum
- ▶ Exposed direct-fastened, low profile panel for roof and wall
- ▶ 36" panel coverage
- ▶ 3/4" bell-top rib height
- ▶ Twin trapezoidal ribs on 9" centers
- ▶ Thickness: 0.0155" and 0.018"
- ▶ Minimum roof slope: 3:12
- ▶ Contact Metal Sales for load-carrying capabilities

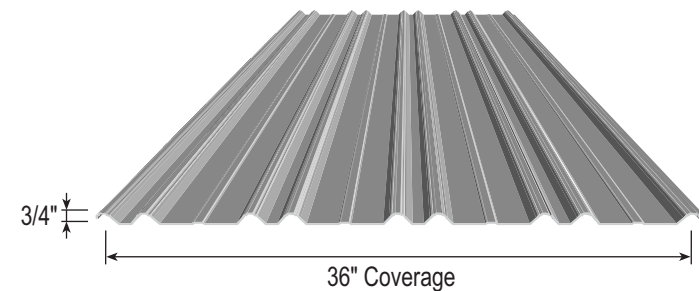

## IMPower Series™

- ▶ Insulated metal wall and roof systems
- ▶ Factory-injected foam insulation between dual steel facings
- ▶ Closed cell insulating core provides approximately R-8 per inch
- ▶ Panel Coverage: 40"
- ▶ Wall Panel Thickness: 2", 2.5", 3" and 4"
- ▶ Roof Panel Thickness: 2.5", 3.25", 4", 5" and 6"
- ▶ Gauges: 26 ga. standard 24 ga. optional
- ▶ Finishes: PVDF and SMP coatings
- ▶ Contact Metal Sales for load-carrying capabilities

### Testing and Approvals

- ▶ ASTM E 283 Air Infiltration
- ▶ ASTM E 331 Water Penetration
- ▶ ASTM E 1646 Water Penetration
- ▶ ASTM E 1680 Air Leakage

### SR2 Standing Seam Roof

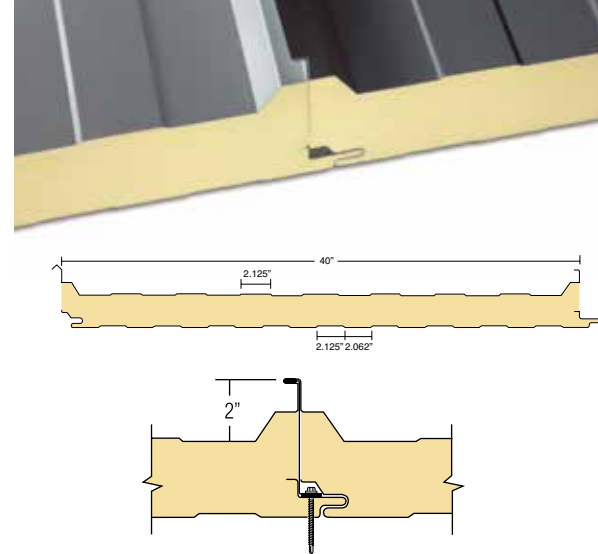

### HR3 High Rib Roof

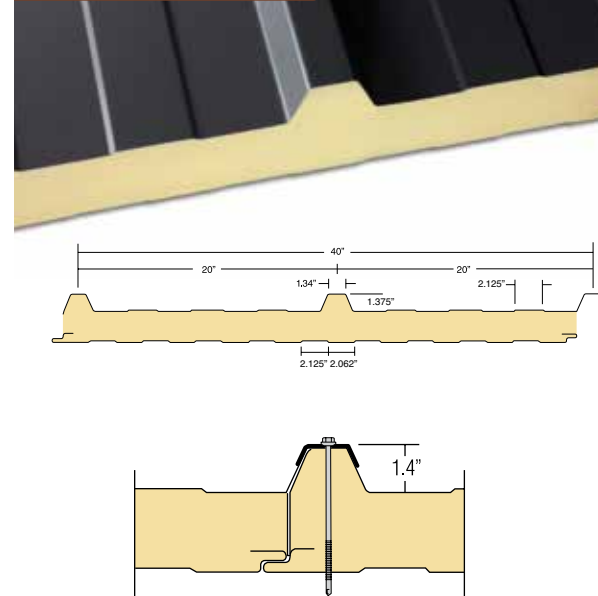

### DM40 Double Mesa Wall

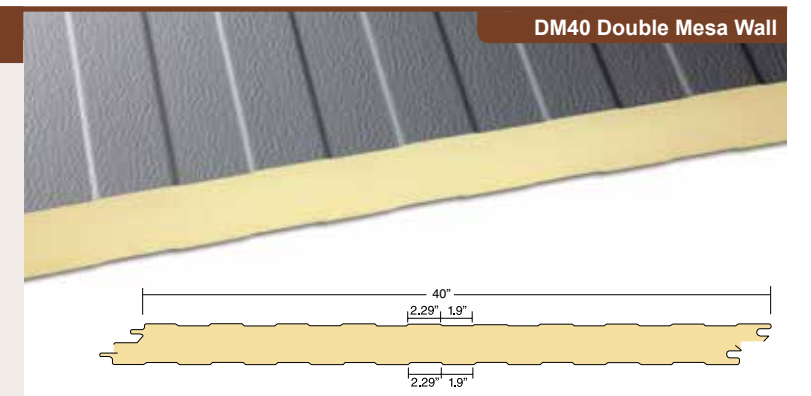

### FL40 Flat Wall

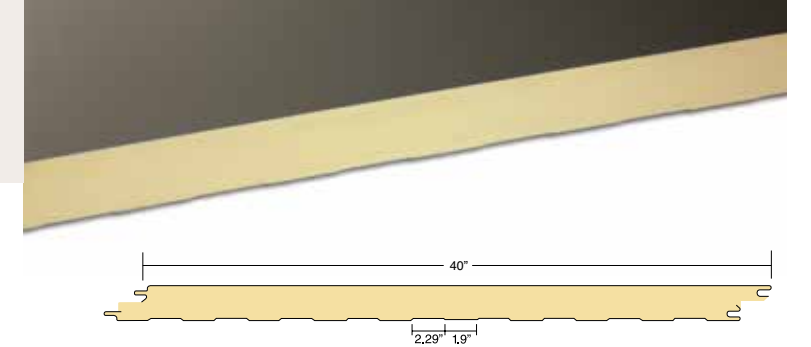

### HE40 Heavy Embossed Wall

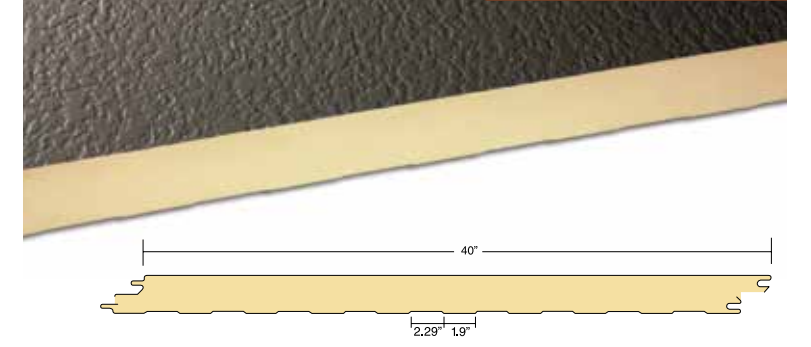

### HE40A AdobeTexture™ Wall

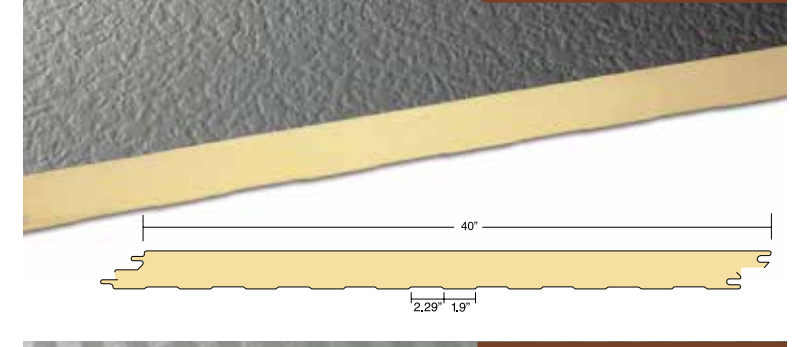

### ST40 Striated Wall

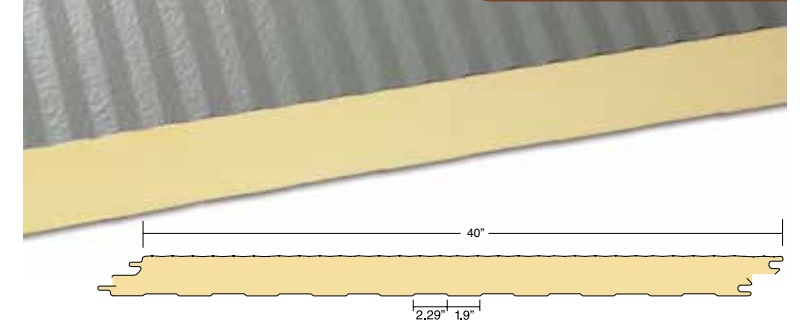

## Retro-Master® System

### Solutions for existing flat roofs

Retro-Master® is a complete retrofit roof system that easily and affordably transforms old and failing roofs into a new code-compliant and energy-efficient sloped metal roof.

As a single-source solution Retro-Master® retrofit roof system is backed by a 20 year weathertight warranty and an industry-leading 45 year paint finish warranty. It is the ideal solution for schools, universities, retail centers, industrial or office building, military or any other building needing a new, long-lasting, high performance roof.

### Solutions for existing sloped metal roofs

If your building has an existing metal roof in need of replacement, Retro-Master® is the most complete and convenient solution. This easy, efficient and virtually waste-free system is installed over your existing roof, allowing your business to operate uninterrupted.

Metal-Over-Metal Reroof Solution combines high quality Metal Sales roof panels with a patented Roof Hugger® sub-purlin retrofit framing system to deliver a new, structurally sound roof that will stand the test of time.

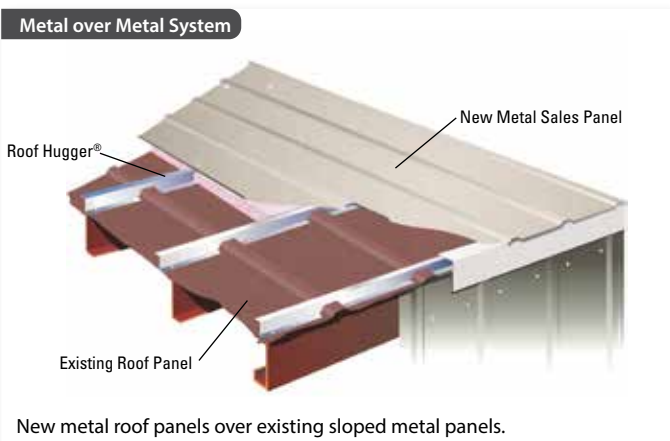
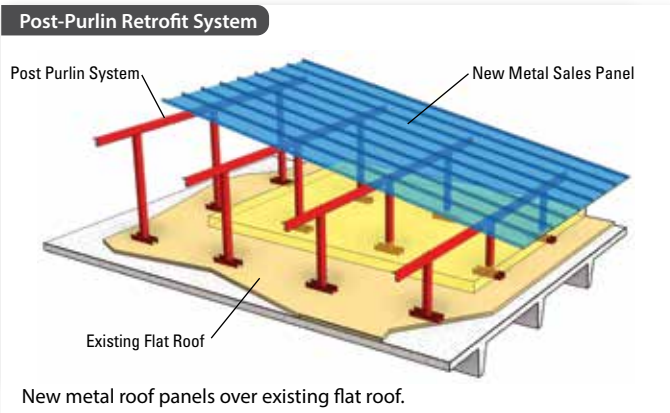

## Perforation

- Perforated panels are an aesthetic design solution
- Wide array of panel profiles
- Available gauges: 24, 22, 20 or 18
- Windscreens, balcony railings, equipment and concealment screens, ventilation and interior liner



## Mitered Corners

- Non-Insulated panels up to 3" deep
- Vertical & Horizontal applications
- Profile widths or modules up to 36"
- +/- 90 Degrees (Inside - Outside - Double Corners)  
Corner leg dimensions up to 4'-0" in either direction



## Curved Panel Options

- Factory and site curving options
- Available profiles: Magna-Loc 180 and Mini-Batten
- Magna-Loc 180: 20' min radius, no max radius
- Mini-Batten: min Convex radius: 4'  
min Concave radius: 6'



## Secondary Framing

- ▶ Ceess and Zees 4" to 12" deep with 2-1/2" to 4" flange widths
- ▶ Symmetrical and unsymmetrical flanges
- ▶ Red Oxide finish ASTM A 1011 Grade 50, Class 2 (55 ksi min yield)
- ▶ Galvanized finish ASTM A 653 Grade 50, Class 2 (55 ksi min yield)
- ▶ Single Slope Eave Struts for high side applications
- ▶ Double Slope Eave Struts for low side applications
- ▶ LGSI Purlins available



### CEES, ZEES AND EAVE STRUTS

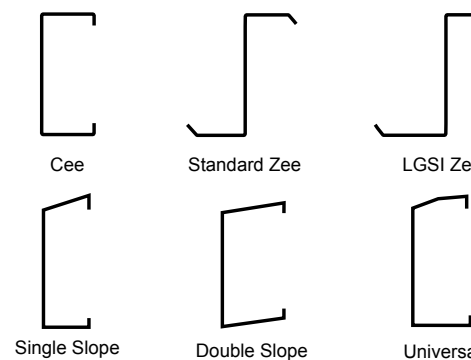

### CHANNELS, HAT SECTIONS AND ANGLES

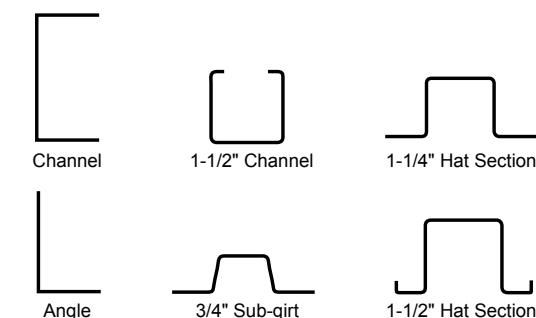

Other Components are available. Please inquire.

## Coating Systems

### Meet or exceed codes and standards

Our advanced coating technology ensures Metal Sales finishes and colors meet demonstrated energy performance requirements established by ENERGY STAR® and the Cool Roof Rating Council (CRR) for solar reflectance and thermal emittance for steep sloped and/or low sloped buildings.

### Benefits of cool colors

Cool roof colors are offered from an engaging palette of light neutrals to dark saturated hues that respect the environment and help achieve your vision. Cool roofs may also contribute to other strategies for optimizing energy performance. Energy savings and other direct benefits are contingent upon building type, location and use.

### Substrate Materials

Our line of durable substrate materials includes steel, stainless steel, weathering steel, copper and aluminum. Your Metal Sales representative has technical information on material and coating compatibility.

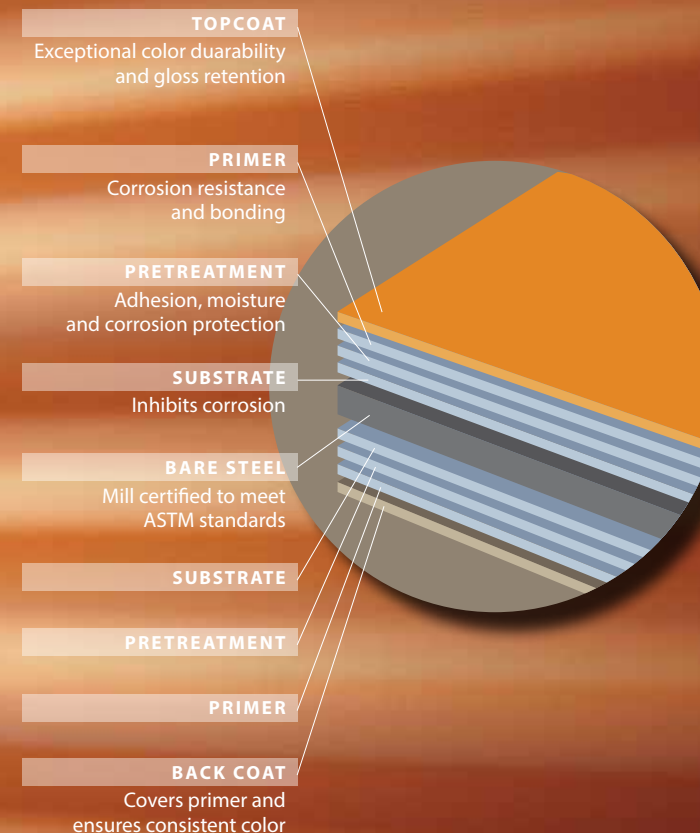

# Metal Sales Branch Locations



## **ANCHORAGE, ALASKA**

4625 Old Seward Highway  
Anchorage, AK 99503  
866.640.7663 • 907.646.7664/Fax

## **BAY CITY, MICHIGAN**

5209 Mackinaw Road  
Bay City, MI 48706  
888.777.7640 • 888.777.0112/Fax

## **DEER LAKE, PENNSYLVANIA**

29 Pinedale Industrial Road  
Orwigsburg, PA 17961  
800.544.2577 • 800.544.2574/Fax

## **DENVER, COLORADO**

7990 East I-25, Frontage Road  
Longmont, CO 80504  
800.289.7663 • 800.289.1617/Fax

## **DETROIT LAKES, MINNESOTA**

1435 Egret Avenue  
Detroit Lakes, MN 56501  
888.594.1394 • 888.594.1454/Fax

## **FONTANA, CALIFORNIA**

14213 Whittram Avenue  
Fontana, CA 92335  
800.782.7953 • 909.829.9083/Fax

## **FORT SMITH, ARKANSAS**

7510 Ball Road  
Fort Smith, AR 72908  
877.452.3915 • 479.646.5204/Fax

## **INDEPENDENCE, MISSOURI**

1306 South Powell Road  
Independence, MO 64057  
800.747.0012 • 800.409.3069/Fax

## **JACKSONVILLE, FLORIDA**

7110 Stuart Avenue  
Jacksonville, FL 32254  
800.394.4419 • 800.413.3292/Fax

## **JEFFERSON, OHIO**

352 East Erie Street  
Jefferson, OH 44047  
800.321.5833 • 800.233.5719/Fax

## **MOCKSVILLE, NORTH CAROLINA**

188 Quality Drive  
Mocksville, NC 27028  
800.228.6119 • 800.228.7916/Fax

## **NASHVILLE, TENNESSEE**

4314 Hurricane Creek Boulevard  
Antioch, TN 37013  
800.251.8508 • 800.419.4372/Fax

## **NEW ALBANY, INDIANA**

999 Park Place  
New Albany, IN 47150  
812.944.2733 • 812.944.1418/Fax

## **ROCK ISLAND, ILLINOIS**

8111 29th Street West  
Rock Island, IL 61201  
800.747.1206 • 309.787.1833/Fax

## **ROGERS, MINNESOTA**

22651 Industrial Boulevard  
Rogers, MN 55374  
800.328.9316 • 800.938.9119/Fax

## **SEATTLE, WASHINGTON**

20213 84th Avenue South  
Kent, WA 98032  
800.431.3470 • 253.872.2008/Fax

## **SELLERSBURG, INDIANA**

7800 State Road 60  
Sellersburg, IN 47172  
800.999.7777 • 800.477.9318/Fax

## **SIOUX FALLS, SOUTH DAKOTA**

2700 West 3rd Street  
Sioux Falls, SD 57104  
888.299.0024 • 888.960.0429/Fax

## **SPOKANE, WASHINGTON**

2727 East Trent Avenue  
Spokane, WA 99202  
800.572.6565 • 509.534.4427/Fax

## **TEMPLE, TEXAS**

3838 North General Bruce Drive  
Temple, TX 76501-6505  
800.543.4415 • 800.543.4473/Fax

## **WOODLAND, CALIFORNIA**

1326 Paddock Place  
Woodland, CA 95776  
800.759.6019 • 530.668.0901/Fax