



PBR

# INFORMACIÓN DEL PRODUCTO

El panel PBR se usa comúnmente para una amplia variedad de aplicaciones residenciales, agrícolas, comerciales e industriales. PBR es un panel estructural y un panel con sujetadores expuestos que se puede usar tanto para aplicaciones de techo como de pared. La pendiente mínima del techo para PBR es de ½:12.

- Anchura de Cobertura – 36"
- Espacio entre Nervaduras – 12" entre centros
- Altura de la Nervadura – 1-1/4"
- Pendiente Mínima – ½:12
- Fijación del Panel – Sistema de Sujeción Expuesta
- Calibre – 26 (Estándar); 29, 24, 22 (Opcional)
- Acabados – Liso (estándar); En relieve (opcional)
- Recubrimientos – Galvalume Plus®, Signature® 200

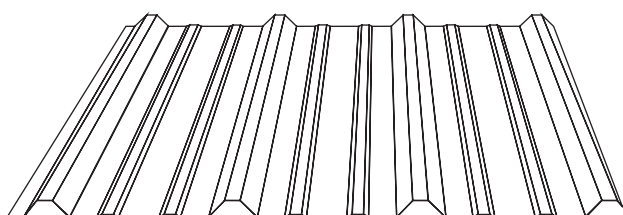

## COLORES DE CALIBRE 26

	HAWAIIAN BLUE★		CHARCOAL GRAY★
	CRIMSON RED★		COBALT BLUE★
	FERN GREEN★		RUSTIC RED★
	BURNISHED SLATE★		LIGHT STONE★
	ASH GRAY★		POLAR WHITE★
	SADDLE TAN★		SOLAR WHITE★★
	DESERT SAND★		GALVALUME PLUS★
	KOKO BROWN★		

★ CALIFICADO ENERGY STAR A TRAVÉS DE NUESTRO SOCIO, MBCI

\* También disponible en calibre 29

\*\* Se pueden requerir cantidades mínimas y/o plazos de entrega extendidos

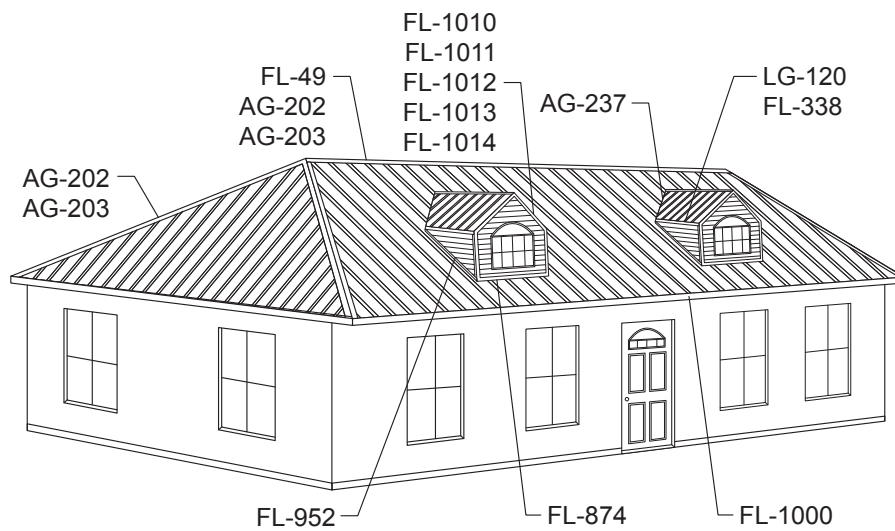

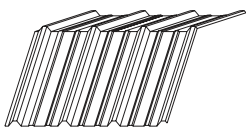
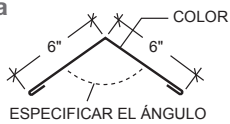
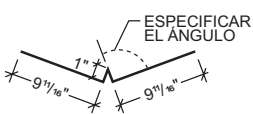
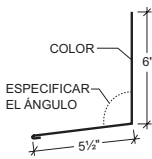
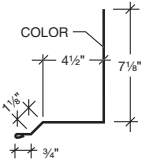
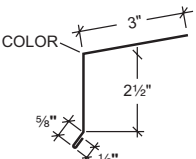
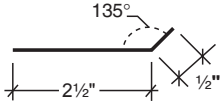
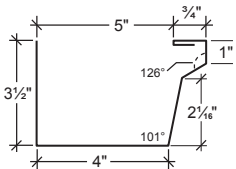
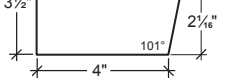
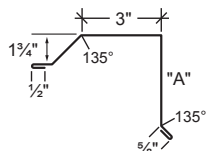
ARTÍCULO	Nº DE PIEZA	PENDIENTE	DIM "A"	LONGITUD	CIRCUNFERENCIA	CALIBRE
<b>Cumbrera Estampada</b> 	FL-49	1:12 - 5:12	N/A	2'-6"	N/A	26 GA
NOTA: Especificar la pendiente del techo • La pendiente máxima del techo es de 5:12						
<b>Tapajuntas de Cumbrera/Lima</b> 	AG-202 AG-203		N/A	10'-2" 20'-2"	13"	26 GA 26 GA
NOTA: Especificar la pendiente del techo y si se usa para la cumbrera o lima						
<b>Limahoya Estándar</b> 	AG-237 AG-238		N/A N/A	10'-2" 10'-2"	20 3/8" 20 3/8"	26 GA 26 GA
NOTA: Especificar la pendiente del techo						
<b>Moldura de Alero Alto de Parapeto</b> 	FL-874 FL-875		N/A N/A	10'-2" 20'-2"	12" 12"	26 GA 26 GA
NOTA: Especificar la pendiente del techo						
<b>Inclinación de Pretil</b> 	FL-952 FL-953		N/A N/A	10' - 2" 20' - 2"	14" 14"	26 GA 26 GA
<b>Moldura de Alero</b> 	LG-120		N/A	10'-6"		29 GA
NOTA: Especificar la pendiente del techo • Especificar el ribete abierto si se usa la abrazadera continua						
<b>Abrazadera Continua</b> 	FL-338		N/A	10'-2"	3"	24 GA
<b>Canalón</b> 	FL-1000		N/A	10'-2"	12 3/16"	24, 26 y 29 GA
<b>Cabecera de Canalón</b> (derecha o izquierda) 	FL-1001		N/A	N/A	N/A	24, 26 y 29 GA
<b>Inclinación</b> 	FL-1010 FL-1011 FL-1012 FL-1013 FL-1014	3-4 : 12 5-6 : 12 7 : 12 8-9 : 12 10 : 12	3 1/16" 3 3/16" 3 7/16" 3 9/16" 3 3/8"	10'-2" 10'-2" 10'-2" 10'-2" 10'-2"	10 13/16" 10 11/16" 10 9/16" 10 7/16" 10 5/16"	26 y 29 GA 26 y 29 GA 26 y 29 GA 26 y 29 GA 26 y 29 GA
NOTA: Especificar el ribete abierto si se usa la abrazadera continua						



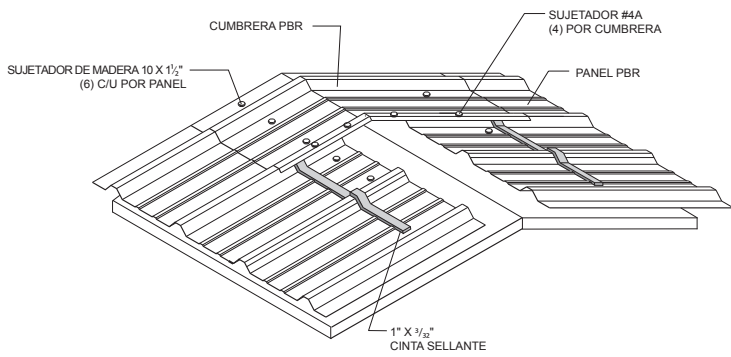

## CUMBRERA

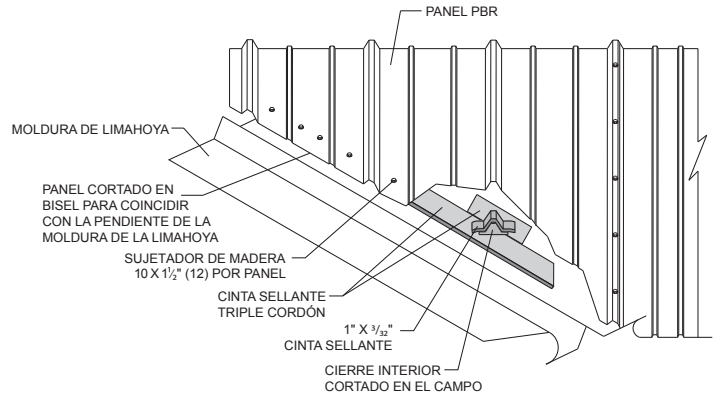

## LIMAHOYA

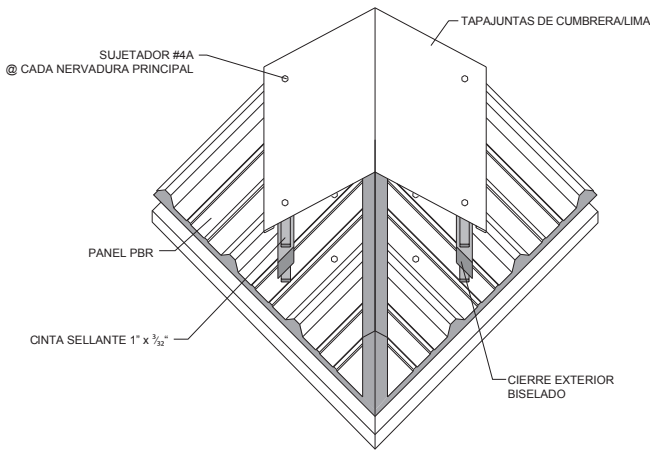

## LIMA

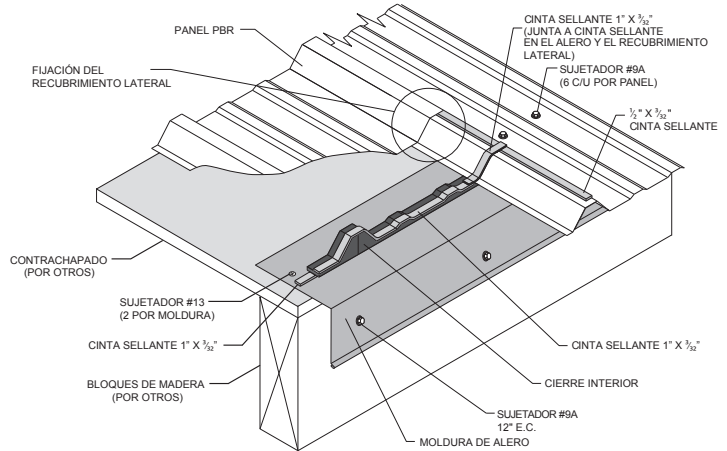

## MOLDURA DE ALERO

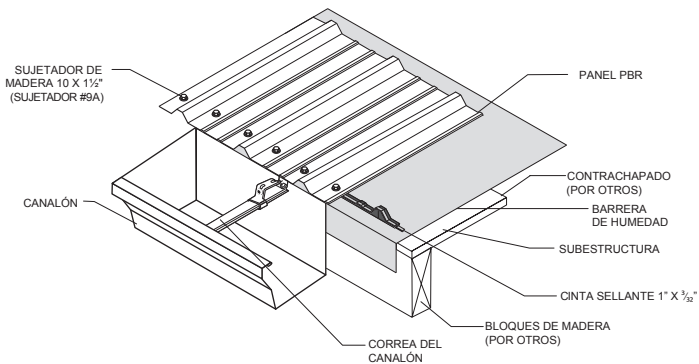

## CANALÓN

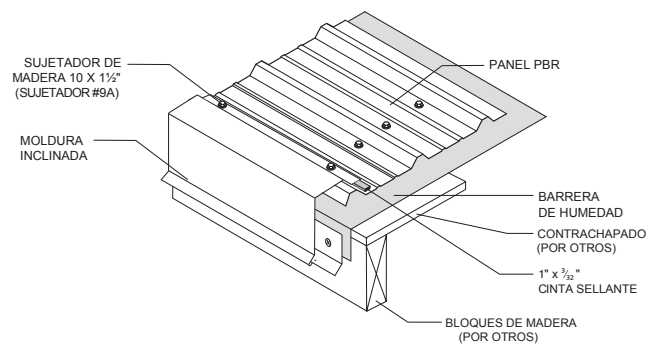

## INCLINACIÓN

## Pintura para Retoques



Nº PIEZA	TIPO	TAMAÑO
HW-304	Signature® 200	2 oz.
HW-305	Signature® 300	2 oz.

## Vasos Magnéticos

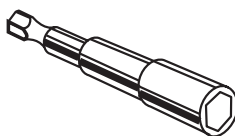

Nº PIEZA	TAMAÑO
HW-604	Accionamiento Hex 3/8"
HW-605	Accionamiento Hex 5/16"
HW-606	Accionamiento Hex 1/4"

## Vasos Magnéticos

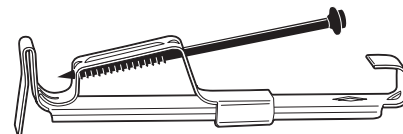

Nº PIEZA
HW-339

## Tiras de Cierre de Panel "PBR"

NOTA: Se requiere una por panel

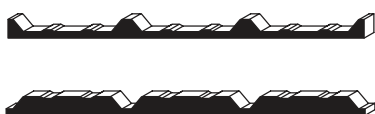

Nº PIEZA	TIPO	ADHESIVO
HW-455	Interior	No
HW-456	Exterior	Sí

## Soporte de Techo de Caucho

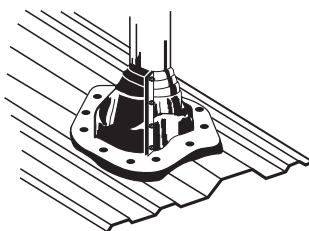

Nº PIEZA	GAMA TEMP.	TAM. TUB.	DIM. BASE	PESO C/U
HW-1000	-65°F a +212°F	1/4" - 2"	4 1/2"	0,17#
HW-1001	-65°F a +212°F	1/4" - 5"	8"	0,50#
HW-1002	-65°F a +212°F	4" - 7"	11"	0,95#
HW-1003	-65°F a +212°F	6" - 11"	14"	1,55#
HW-1004	-65°F a +212°F	7" - 13"	17"	2,56#
ALTA TEMPERATURA				
HW-1046	-100°F a +437°F	1/4" - 5"	8"	0,50#
HW-1047	-100°F a +437°F	4" - 7"	11"	0,95#
HW-1048	-100°F a +437°F	7" - 13"	17"	2,56#
HW-1049	-100°F a +437°F	10" - 18"	25"	3,86#

## Autoperforante Lap-Tek

250 por Bolsa

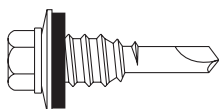

Nº PIEZA	TAMAÑO DE CABEZA	LONGITUD
4A	5/16"	14 x 7/8"

## Sujetador de Madera de Larga Duración

Panel a Madera Maciza

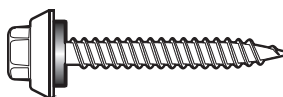

\*Otros tamaños disponibles. Por favor pregunte.

Nº PIEZA	TAMAÑO DE CABEZA	LONGITUD
9A	5/16"	10 x 1"
9	5/16"	10 x 1 1/2"

## Remache Pop

250 por Bolsa | Acero Inoxidable



Nº PIEZA	DIÁMETRO	RANGO DE AGARRE
14	1/8"	3/16"

## Sujetador de Madera

Panel a Madera Maciza

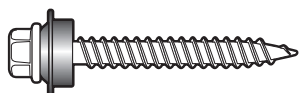

\*Otros tamaños disponibles. Por favor pregunte.

Nº PIEZA	TAMAÑO DE CABEZA	LONGITUD
8A	1/4"	10 x 1"
8	1/4"	10 x 1 1/2"
8B	1/4"	10 x 2"
8C	1/4"	10 x 2 1/2"

## Cinta Sellante

Plana

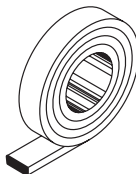

Nº PIEZA	GENERAL	LONGITUD
HW-502	2 1/2" x 3/16"	20'-0"
HW-504	7/8" x 3/16"	25'-0"
HW-507	1/2" x 3/32"	50'-0"
HW-508	1" x 3/32"	40'-0"

## Tubo de Sellante

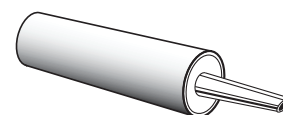

Nº PIEZA	TIPO	COLOR
HW-548	Acrílico	Blanco
HW-550	Acrílico	Gris
HW-540	Uretano	Blanco
HW-541	Uretano	Gris
HW-542	Uretano	Bronce
HW-544	Uretano	Almendra

NOTA: 25' por tubo para un cordón de 1/4"